

IDE INTERFACE

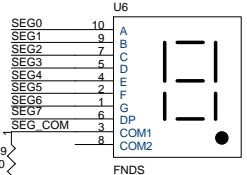

Small FNDO

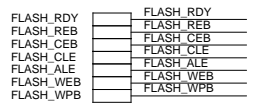
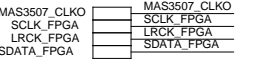
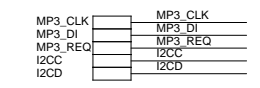
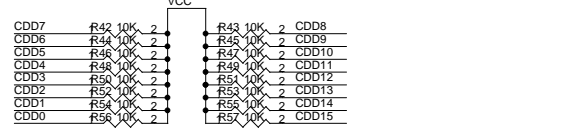
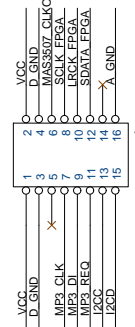
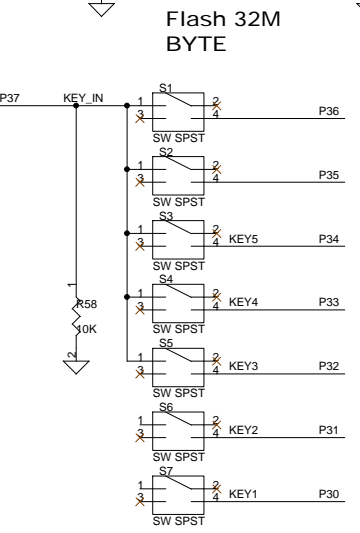
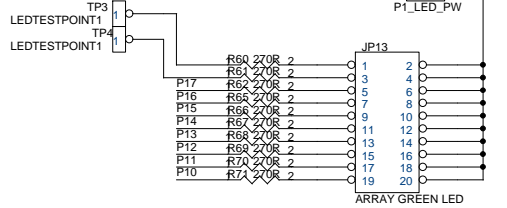
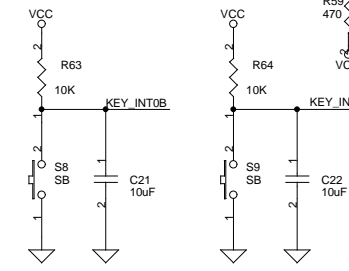

MAS3507 CONNECTION PINS

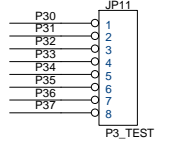
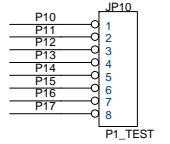
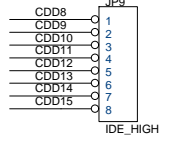
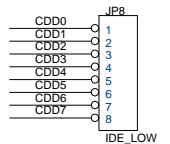

Title		
CODEC		
Size	Document Number	Rev
Custom	MEDE BY Jong-Seuk Park	1.0
Date:	Friday, June 08, 2001	Sheet 3 of 5