

NetlistViewer Standalone v6.1 User's Guide

Viewing Your Netlist



Actel Corporation, Mountain View, CA 94043

© 2004 Actel Corporation. All rights reserved.

Printed in the United States of America

Part Number: 5-02-9135-3

Release: December 2004

No part of this document may be copied or reproduced in any form or by any means without prior written consent of Actel.

Actel makes no warranties with respect to this documentation and disclaims any implied warranties of merchantability or fitness for a particular purpose. Information in this document is subject to change without notice. Actel assumes no responsibility for any errors that may appear in this document.

This document contains confidential proprietary information that is not to be disclosed to any unauthorized person without prior written consent of Actel Corporation.

Trademarks

Actel and the Actel logotype are registered trademarks of Actel Corporation.

Adobe and Acrobat Reader are registered trademarks of Adobe Systems, Inc.

Mentor Graphics, Precision RTL, Exemplar Spectrum, and Leonardo Spectrum are registered trademarks of Mentor Graphics, Inc.

WaveFormerLite is a registered trademark of SynaptiCAD, Inc.

Synplify is a registered trademark of Synplicity, Inc.

Sun and Sun Workstation, SunOS, and Solaris are trademarks or registered trademarks of Sun Microsystems, Inc

Synopsys is a registered trademark of Synopsys, Inc.

Verilog is a registered trademark of Open Verilog International.

Viewlogic, ViewSim, ViewDraw and SpeedWave are trademarks or registered trademarks of Viewlogic Systems, Inc.

Windows is a registered trademark and Windows NT is a trademark of Microsoft Corporation in the U.S. and other countries.

UNIX is a registered trademark of X/Open Company Limited.

All other products or brand names mentioned are trademarks or registered trademarks of their respective holders.

Table of Contents

Welcome to NetlistViewer Standalone	1
Starting NetlistViewer Standalone	1
Components of NetlistViewer Standalone	2
Schematic Window.....	3
Search Tool Window.....	4
Hierarchy Window.....	5
Navigating through Your Netlist	5
Selecting Objects	6
Highlighting Objects.....	7
Searching for Objects	8
Using NetlistViewer with ChipEditor	9
Using NetlistViewer Standalone with Timer	11
Debugging Simulation Results.....	14
Identifying Paths	15
Viewing Buffers.....	20
Menus, Toolbar Buttons, and Shortcut Keys	21
Contacting Actel.....	23

Welcome to NetlistViewer Standalone

The NetlistViewer tool displays the contents of the design as a schematic, making it easier for you to debug your design. Use this tool to view nets, ports, and instances and to trace signals. Used with PinEditor, ChipEditor, or Timer, NetlistViewer assists you in meeting area and timing goals by helping you identify critical paths.

You can start NetlistViewer only after the design has been compiled.

Note: This version of NetlistViewer supports only the MX, SX-A, eX, RTSX, and RTSX-S families. If you are designing for the ProASIC3E, ProASIC3, ProASIC ^{PLUS}, Axcelerator, and ProASIC families, use NetlistViewer in MultiView Navigator. See the MultiView Navigator User's Guide for more information.

Starting NetlistViewer Standalone

NetlistViewer is available from Designer's main window. You can only start it after your design is compiled. To start NetlistViewer from Designer, either click the **NetlistViewer** icon in the Designer Design Flow window, or from the **Tools** menu, choose **NetlistViewer**. NetlistViewer reads your netlist design and generates a clearly-laid out schematic

NetlistViewer reads your netlist design and generates a clearly-laid out schematic view, as shown in the figure below.

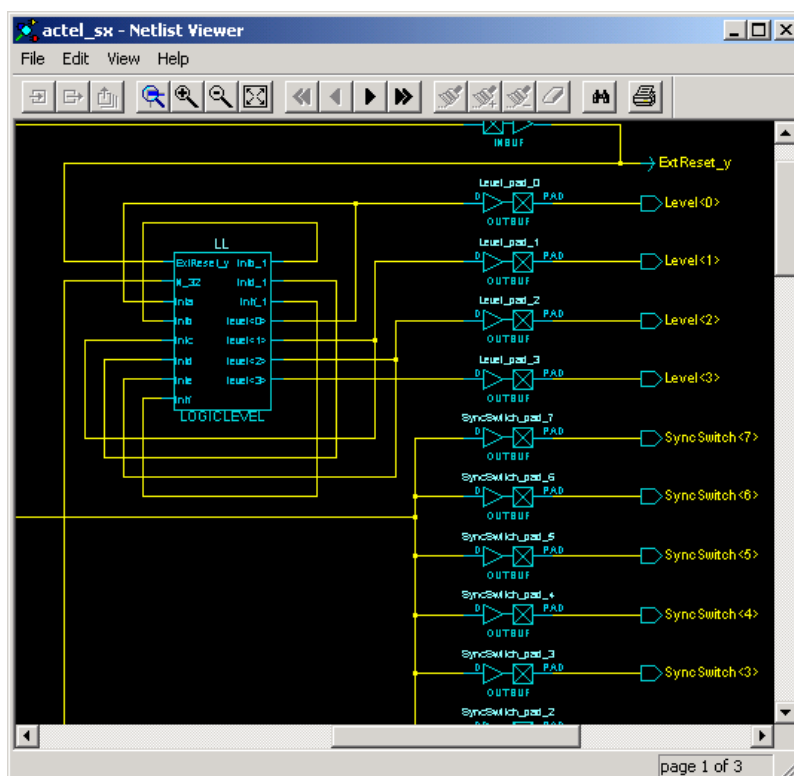

NetlistViewer Standalone

Components of NetlistViewer Standalone

NetlistViewer consists of three windows:

- Schematic
- Hierarchy View
- Search Tool

NetlistViewer also contains a menu bar, toolbar, and status bar.

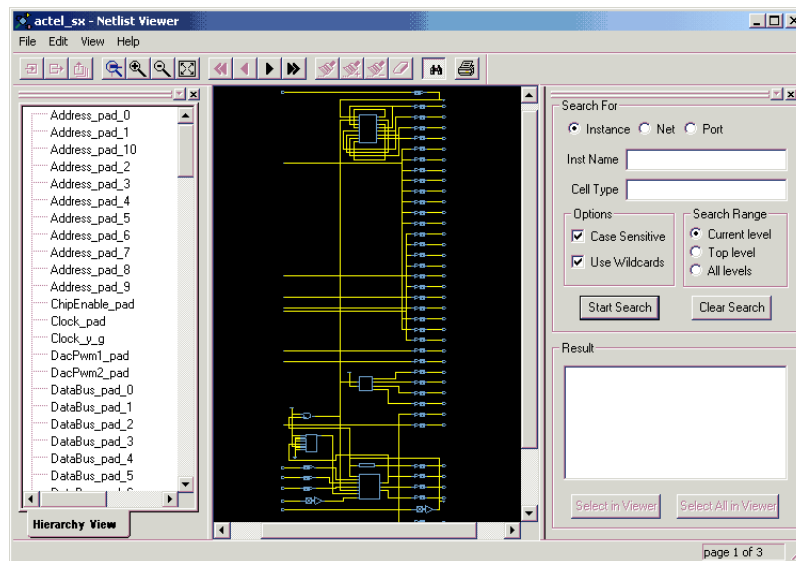

NetlistViewer with All Windows Open

Schematic Window

The Schematic window displays a graphical representation of the netlist. It automatically opens when you start NetlistViewer.

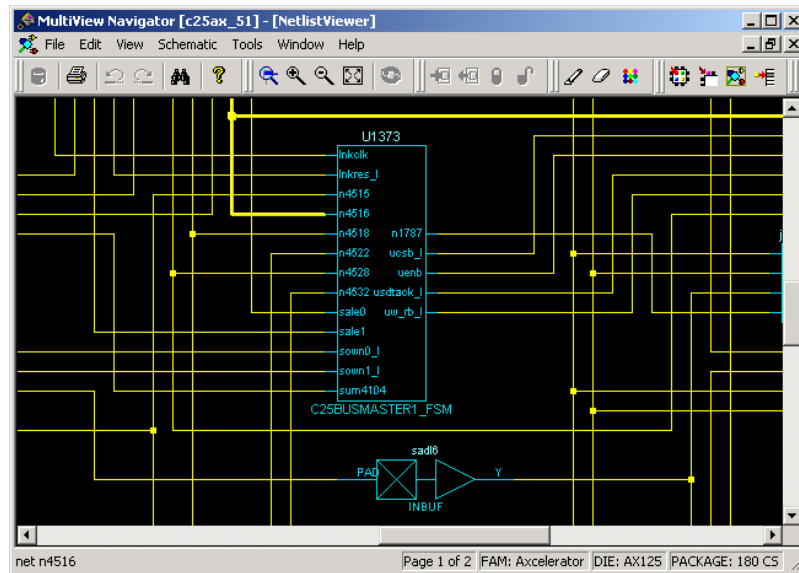

Schematic Window

Search Tool Window

Use the Search Tool window to search for instances, nets, and ports.

To open the Search Tool window, from the **View** menu, choose **Search Tool**. The Search Tool window opens to the right of the Schematic window. This window is sizable and dockable.

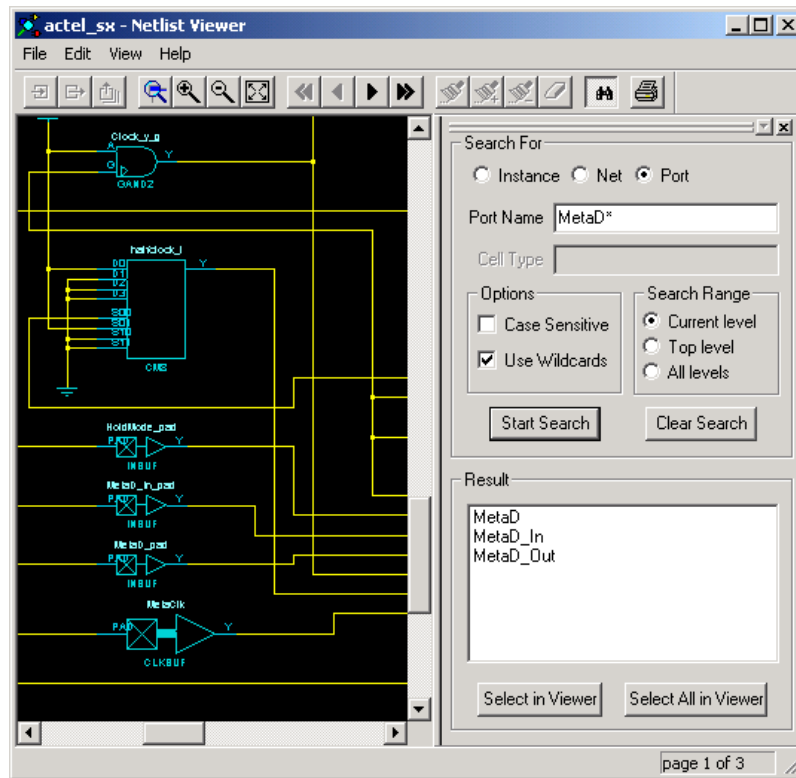

Search Tool Window

Hierarchy Window

The Hierarchy window provides easy navigation through the design hierarchy and gives a compact hierarchy overview. When you select an instance in this window, it appears highlighted in the NetlistViewer window. To view the Hierarchy window in NetlistViewer Standalone, from the **View** menu, choose **Hierarchy**. The Hierarchy View window opens. This window is sizable and dockable.

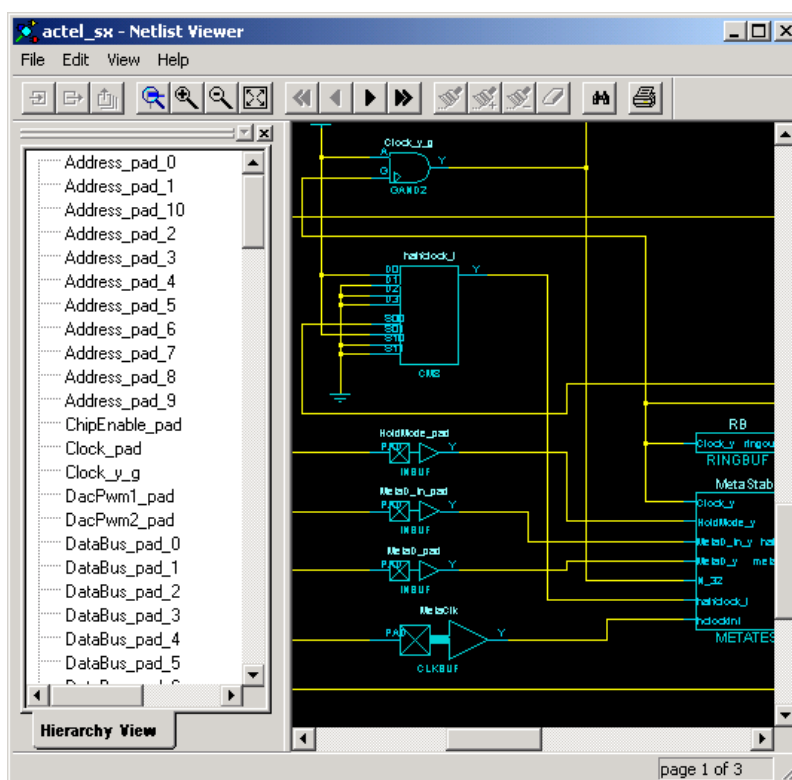

Hierarchy Window

Navigating through Your Netlist

You can navigate in the logical view of the design in two directions: vertically and horizontally.

Vertical Navigation

Navigate vertically through your hierarchical design by using the **Push**, **Pop**, and **Top** commands. These commands are available from the **Edit** menu, the right-click menu, and the toolbar. You can also use the following keyboard shortcuts:

- CTRL-P for Push
- CTRL-O for Pop
- CTRL-T for Top

To go one level deeper in a design:

1. Select an instance.
2. From the **Edit** menu, choose **Push**, or from the right-click menu, choose **Push instance <name>**.

To go one level higher in a design, from the **Edit** menu, choose **Pop**. To go to the top level, from the **Edit** menu, choose **Top**.

Horizontal Navigation

When large designs do not fit in the Schematic window, NetlistViewer splits the design into multiple pages. Page splitting enables you to quickly compute and display the schematic.

To navigate to the next page in a design, from the **View** menu, choose **Go to Next Page**, or click the **Next Page** button in the toolbar.

To navigate to the previous page, from the **View** menu, choose **Go to Previous Page**, or click the **Previous Page** button in the toolbar.

To navigate to the first page, from the **View** menu, choose **Go to First Page**, or click the **First Page** toolbar button.

To navigate to the last page, from the **View** menu, choose **Go to Last Page**, or click the **Last Page** toolbar button.

Following Nets

Following a net might take you to another page or another level in your design. Following nets is useful when your design is split into several pages or if it includes some hierarchical logic. To follow a net, click a net that continues before or after the page being viewed. Nets that continue on other pages are terminated by a page connector symbol (>). Note that a net can continue on many pages.

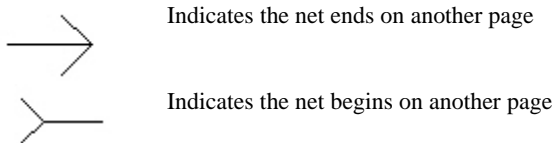

The illustrations below show two pages including net data_6. On both pages, the net ends with the page connector symbol (>), indicating the net continues on another page. As stated earlier, the net can continue on many pages.

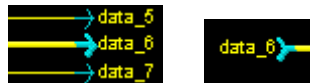

Symbols for a Continuing Net

Selecting Objects

Before you can highlight an object, you must first select it. To select an object, left-click it.

To select a group of objects in NetlistViewer, press and hold down **SHIFT**, and then click each object to select.

To unselect specific selected objects, press and hold down **SHIFT**, and then click a selected object to unselect it. You can also hold down the left mouse button and drag a rectangle toward the bottom-right corner. Release the mouse button when all items you want to unselect are included in the rectangle.

To unselect all selected objects, click a clear spot in the **Schematic** window.

Highlighting Objects

Highlight objects or groups of objects for easy reference. By default, highlighted objects are displayed in red in NetlistViewer.

To highlight an object:

1. Select the object in the NetlistViewer.
2. From the **Edit** menu, choose **Highlight**, or click the **Highlight** button in the toolbar. The object changes color.

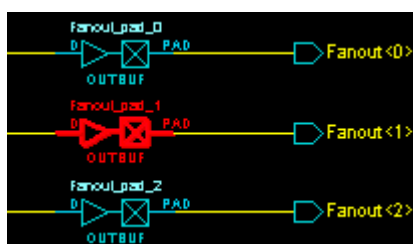

Highlighted Object

To highlight a group of objects:

1. Press and hold down the **SHIFT** key, and then click each object you want to highlight.
2. From the **Edit** menu, choose **Highlight**, or click the **Highlight** toolbar button. This can be useful for tracing a net.

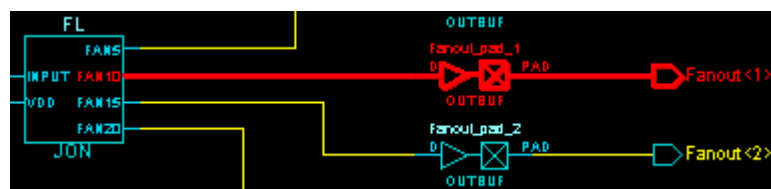

Highlighting Groups of Objects

To unhighlight an object or group of objects:

1. Select the object(s) to highlight.
2. From the **Edit** menu, choose **Un-Highlight**, or click the **Unhighlight** toolbar button.

To unhighlight all highlighted objects, from the **Edit** menu, choose **Clear Highlight**, or click the **Clear Highlight** toolbar button.

Highlight Append

The Highlight Append command highlights the currently selected object and adds it to the highlighted group, which includes the last highlighted object.

To highlight and append an object:

1. Select the object in the NetlistViewer.
2. From the **Edit** menu, choose **Highlight Append**, or click the **Highlight Append** button in the toolbar. The object changes color.

Searching for Objects

Searching for objects can shorten your debug time, since you can locate an instance, net, or port in a complex design without pushing, popping, or scrolling. Use the Search Tool window to search for instances, nets, and ports.

To search for an instance, net, or port:

1. From the **View** menu, choose **Search Tool**. The Search Tool window opens to the right of the Schematic window. This window is sizable and dockable.
2. Select **Instance**, **Net**, or **Port** in the **Search For** area.
Type the text you are looking for in the **Name** area. You can refine your search by specifying a **Cell Type** (on the Instance tab).

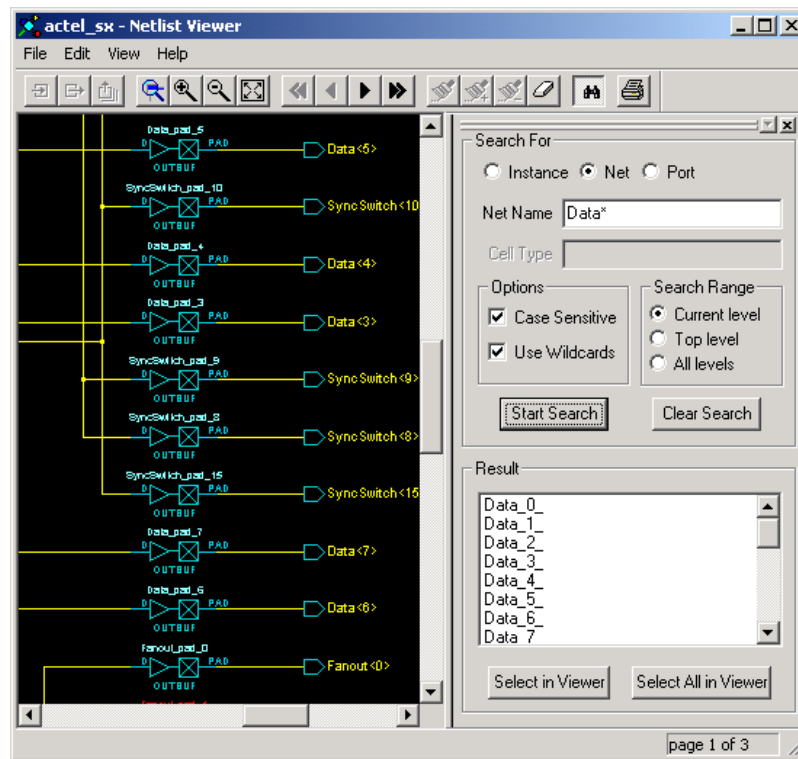

Search Tool Window

The **Name** and **Cell Type** fields accept regular expressions. Wildcard characters in regular expressions include:

Wildcard	What It Does
?	Matches any single character
*	Matches any string
[]	Matches any single character among those listed between brackets (that is, [A-Z] matches any single character in the A-to-Z range)
/	This is the level-bordering symbol. "A/B" designates "object B, which is part of instance A."

3. Select from among the following search options:
4. **Case Sensitive** - Select this check box if you want the search to return only items that match the case of the items you entered.
5. **Use Wildcards** - Select this check box if you used wildcards in the Name or Cell Type fields.
6. **Search Range** - Select a search range to limit your search to a hierarchical level.

7. Click **Start Search**. The located objects, if any, appear in the **Result** list box.
8. Select one or several objects in the Result list box, and then click either **Select in Viewer** or **Select All in Viewer** to locate your object(s) in the Schematic window.

Using NetlistViewer with ChipEditor

If both NetlistViewer and ChipEditor are open, items selected in either tool are automatically selected in the other.

To use NetlistViewer with ChipEditor:

1. Click **NetlistViewer** in Designer's Design Flow window. NetlistViewer starts, displaying your netlist.
2. Start ChipEditor. ChipEditor opens in a separate window and displays the logic and I/O modules on the device.

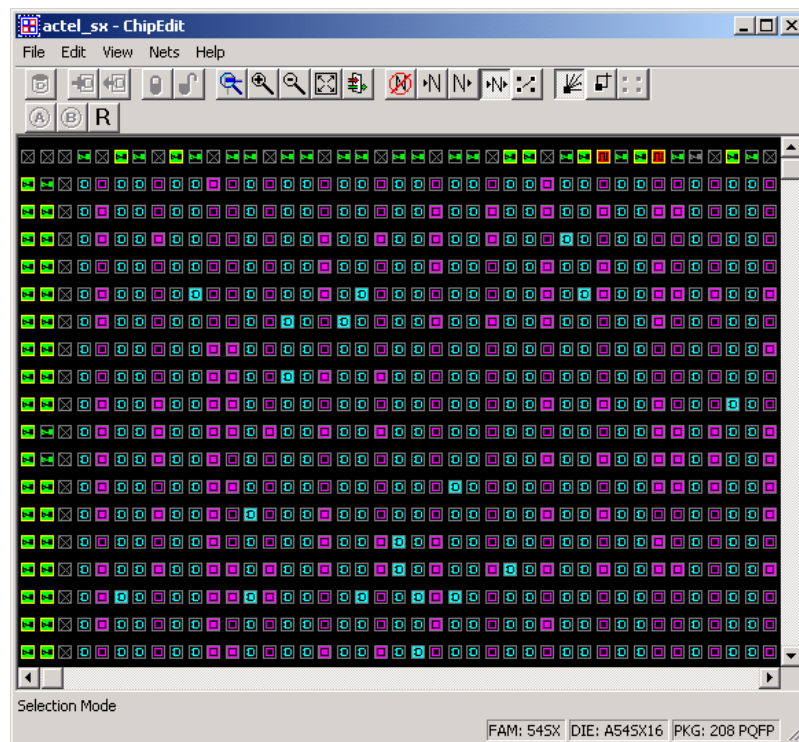

ChipEditor Window

3. Selecting a macro or instance in ChipEditor automatically selects it in NetlistViewer too. Likewise, selecting a macro or instance in NetlistViewer also selects it in ChipEditor.



Item Selected in NetlistViewer



NetlistViewer Selected Item in ChipEditor

For more information about ChipEditor, see the ChipEditor User's Guide.

Using NetlistViewer Standalone with Timer

Use NetlistViewer with Timer to view and trace Timing paths.

To trace paths using NetlistViewer and Timer:

1. Choose **NetlistViewer** in Designer's Design Flow window. Note: Your design must be compiled in order to start NetlistViewer. If it is not compiled, Designer prompts you to do so. NetlistViewer starts and displays your netlist.
2. Click **Timer** in Designer Design Flow window. The Timer window opens.

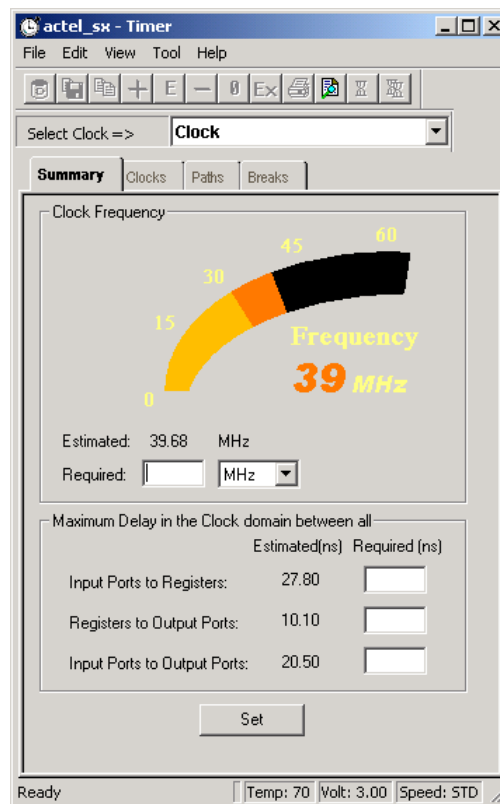

Timer

- Click the Timer **Paths** tab.

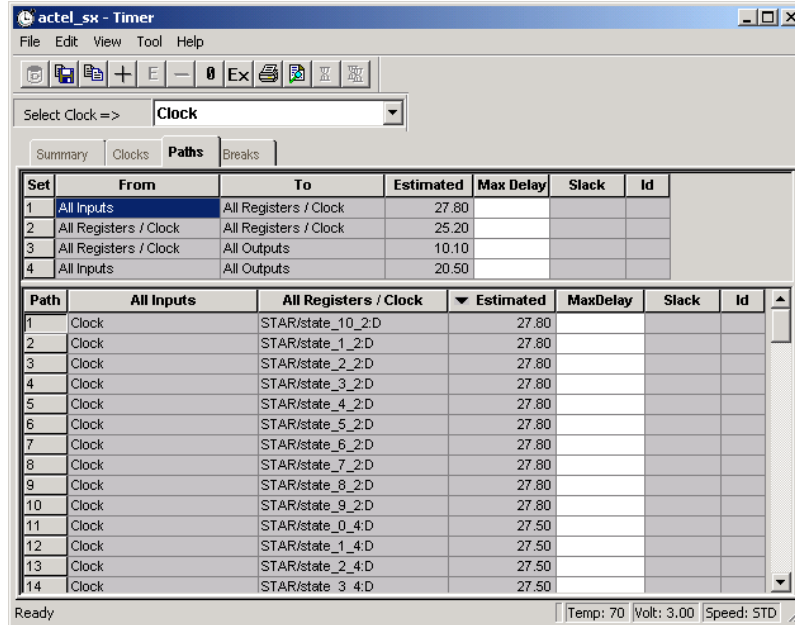

Paths Tab

- Select a path set in the **Path Set** table. Paths within that set are displayed below in the Path Set window.
- Select the path you wish to expand.
- Double-click the path to expand it, or from the **Edit** menu, choose **Expand Paths**. The Expanded Paths window opens, as shown below. The **Expanded Paths** window displays the path in the Expanded Paths grid and a graphical representation of the path in the Graph window.

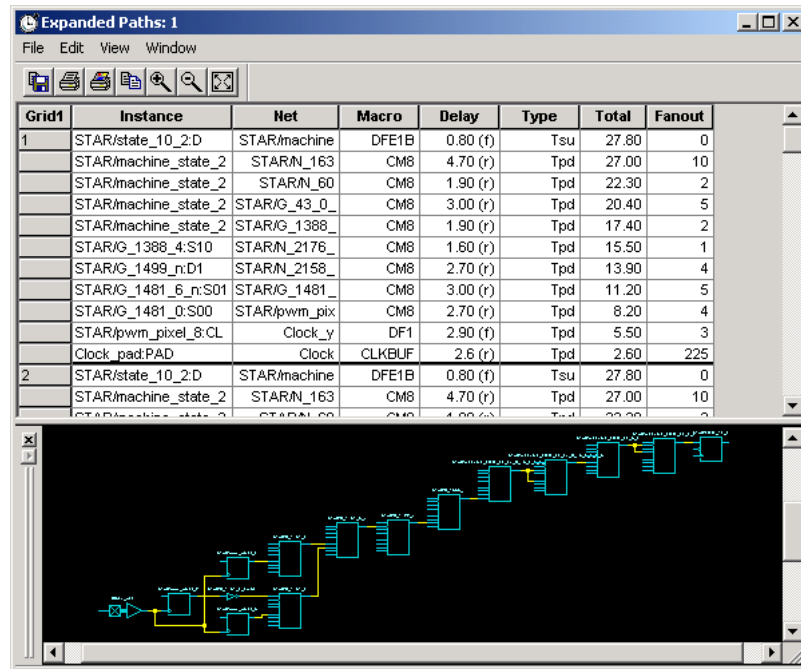

Timer Expanded Paths Window

7. Select an instance in Timer's **Expanded Paths** grid or in the Graph window. The instance is highlighted in the NetlistViewer.

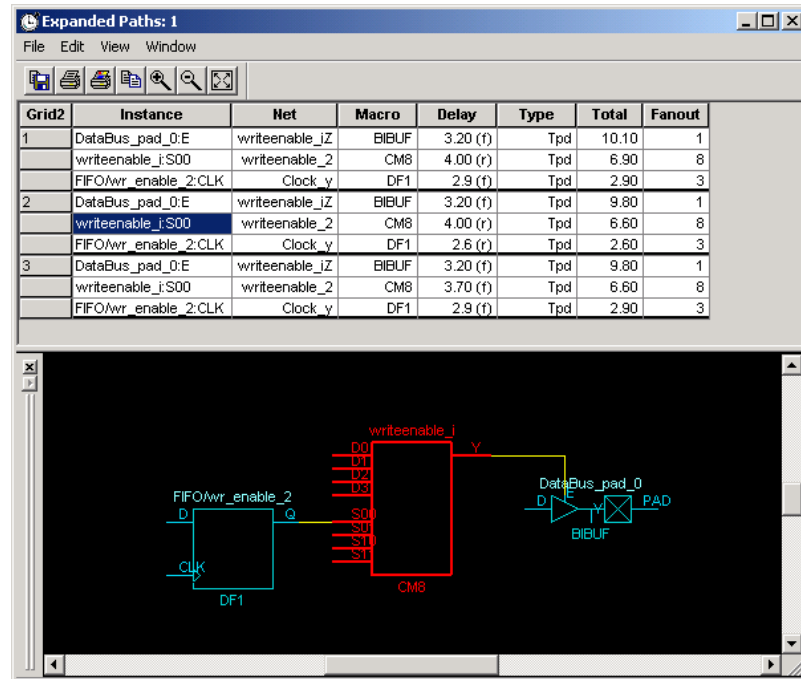

Instance Selected in Timer

8. Select the first register in the **Timer** path and locate it in the NetlistViewer. Follow the entire path in NetlistViewer.

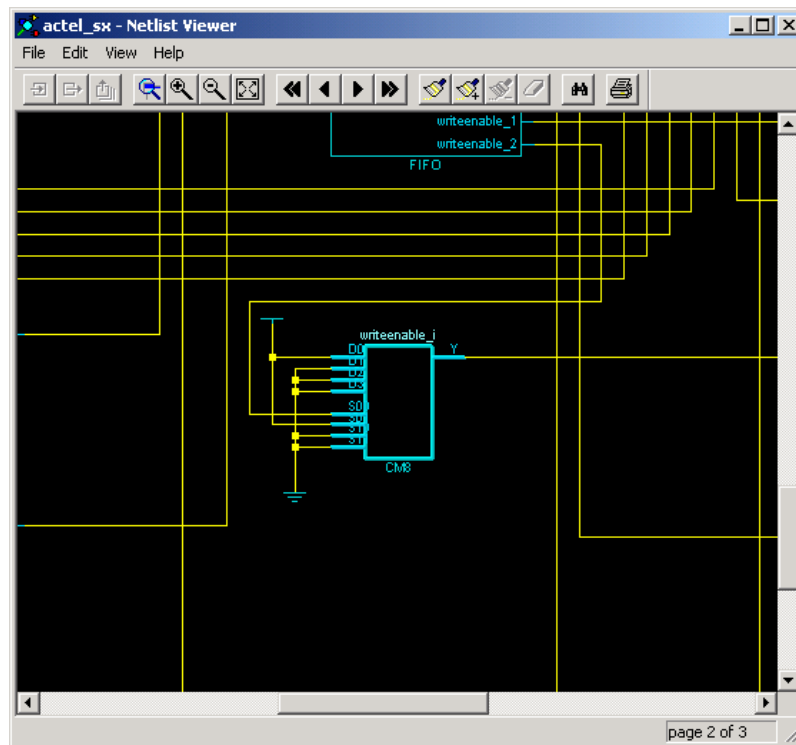

Instance Selected in Timer Highlighted in NetlistViewer

For more information about Timer, see the Timer User's Guide.

Debugging Simulation Results

The NetlistViewer tool is useful for debugging your netlist when simulation results are complex or conflicting with design constraints.

In most cases, this occurs when the output of a flip-flop is being fed back into the input without a reset, preset, or clear input. NetlistViewer can help you verify that such a flip-flop configuration exists in the design.

To locate and view the flip-flops:

1. Click **NetlistViewer** in the Design Flow window.
2. Zoom to locate the flip-flops.

Identifying Paths

In this example, the NetlistViewer is used with Timer to identify the inputs of combinational gates. For more detailed information about Timer, see the Timer User's Guide.

To identify these paths:

1. From Designer, start NetlistViewer by clicking **NetlistViewer** in the Design Flow window. The NetlistViewer starts and displays your netlist.

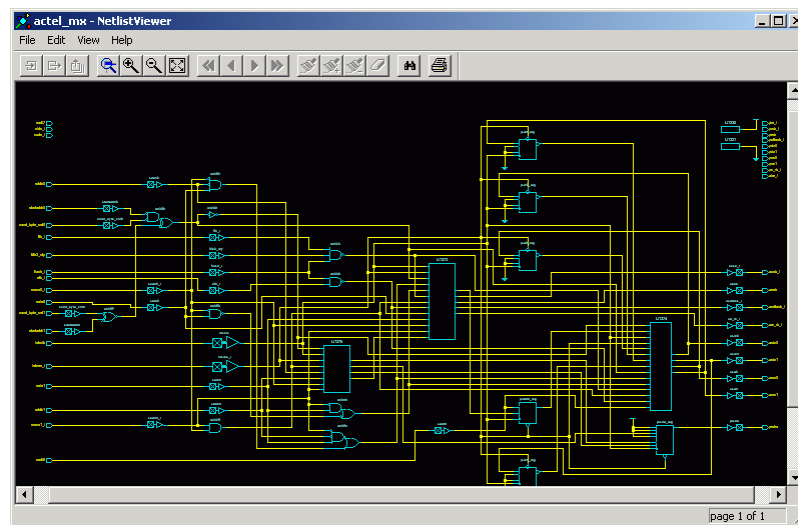

Starting NetlistViewer

- From Designer, start Timer by clicking **Timer** in the Designer Flow Window. Timer starts.

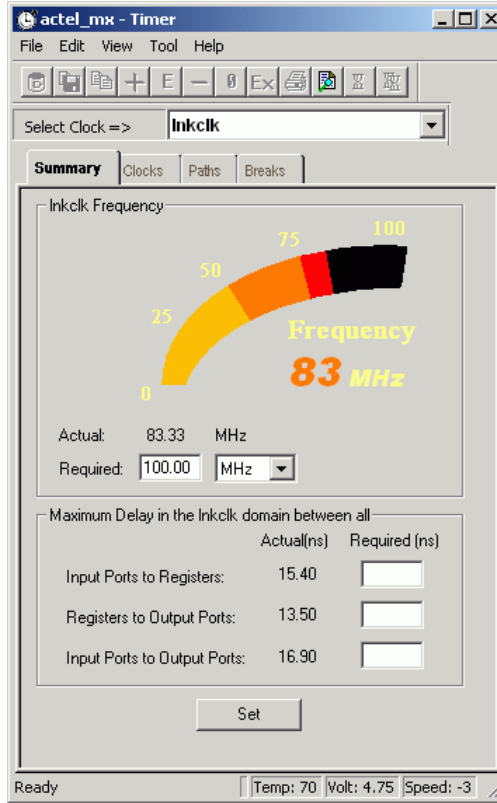

Starting Timer

- In Timer, click the **Paths** tab. The **Paths** tab displays timing analysis information for several categories of paths (by default), known as “sets,” in the Path Set window. When you select a set in the Path Set window, the paths within that set are displayed in the lower table.

Set	From	To	Actual	Max Delay	Slack	Id
1	All Inputs	All Registers / Inkclk	15.40			
2	All Registers / Inkclk	All Registers / Inkclk	12.00			
3	All Registers / Inkclk	All Outputs	13.50			
4	All Inputs	All Outputs	16.90			
5	Inkclk Inkres_ sadi6	ucsb_ uenb usdtack_ usiz0	14.80	11.00	-3.80	DEL1
6	U1373/st7:CLK U1373/st8:CLK	U1373/st3:D U1373/st6:D	4.80	11.00	6.20	DEL2

Path	From	To	Actual	MaxDelay	Slack	Id

Timer's Paths Tab

- Select a path. Timer displays the paths within that set in the lower table.
- Double-click a path (in the lower paths table) to see a graphical representation of the path. The Expanded Paths window opens.

Grid1	Instance	Ilet	Macro	Delay	Type	Total	Fanout
1	U1373/st11:D	U1373/m19	DFP1B	1.80 (f)	Tsu	15.40	0
	U1373/U37:D	U1373/m14	AO3B	1.90 (r)	Tpd	13.60	1
	U1373/U29:C	U1373/m11	AO3A	2.20 (r)	Tpd	11.70	2
	U1373/U30:A	n4516	INV	2.20 (r)	Tpd	9.50	3
	U1351:D	n4567	AO3B	2.70 (f)	Tpd	7.30	7
	U1350:A	sown0_l	AND3B	1.80 (f)	Tpd	4.60	1
	sown0_l:PAD	sown0_l	INBUF	2.8 (r)	Tpd	2.80	5
2	U1373/st11:D	U1373/m19	DFP1B	1.80 (f)	Tsu	15.10	0
	U1373/U37:D	U1373/m14	AO3B	1.90 (f)	Tpd	13.30	1
	U1373/U29:C	U1373/m11	AO3A	2.00 (f)	Tpd	11.40	2
	U1373/U30:A	n4516	INV	2.10 (f)	Tpd	9.40	3
	U1351:D	n4567	AO3B	2.90 (r)	Tpd	7.30	7
	U1350:A	sown0_l	AND3B	1.90 (r)	Tpd	4.40	1

Expanding the Path

The Expanded Paths window displays the path in the Expanded Paths table and a graphical representation of that path in the Graph window. Notice that the inputs of combinational gates are not displayed in the Graph window. It is useful to know where these paths come from because they might indicate a false path that is never encountered and can affect the timing report. It is also important to know how other inputs to these macros interact with the indicated path, because this helps you define appropriate paths, which are essential for obtaining accurate timing reports.

The screenshot shows the 'Expanded Paths: 1' window with a table of path data and a circuit diagram below it. The table lists various components and their timing characteristics. The circuit diagram shows a network of combinational gates including AND3B, AO3B, INBUF, NAND2A, and AO1D, with a red circle highlighting a specific path through an AND3B gate.

Grid#	Instance	Net	Macro	Delay	Type	Total	Fanout
	U1373U29:C	U1373m11	AO3A	2.00 (f)	Tpd	11.40	2
	U1373U30:A	n4516	INV	2.10 (f)	Tpd	9.40	3
	U1351:D	n4567	AO3B	2.90 (r)	Tpd	7.30	7
	U1350:A	sown0_I	AND3B	1.90 (r)	Tpd	4.40	1
	sown0_I PAD	sown0_I	INBUF	2.5 (f)	Tpd	2.50	5
3	U1373st11:D	U1373m19	DFP1B	1.80 (f)	Tsu	11.20	0
	U1373U37:A	n4516	AO3B	1.90 (r)	Tpd	9.40	1
	U1351:D	n4567	AO3B	2.90 (f)	Tpd	7.50	7
	U1350:A	sown0_I	AND3B	1.80 (f)	Tpd	4.60	1
	sown0_I PAD	sown0_I	INBUF	2.8 (r)	Tpd	2.80	5
4	U1373st11:D	U1373m19	DFP1B	1.80 (f)	Tsu	11.00	0
	U1373U37:A	n4516	AO3B	1.90 (f)	Tpd	9.20	1
	U1351:D	n4567	AO3B	2.90 (r)	Tpd	7.30	7

Combinational Gates in Timer's Expanded Paths Window

- Select the macro in the Graph window. The macro is located and selected in the NetlistViewer.

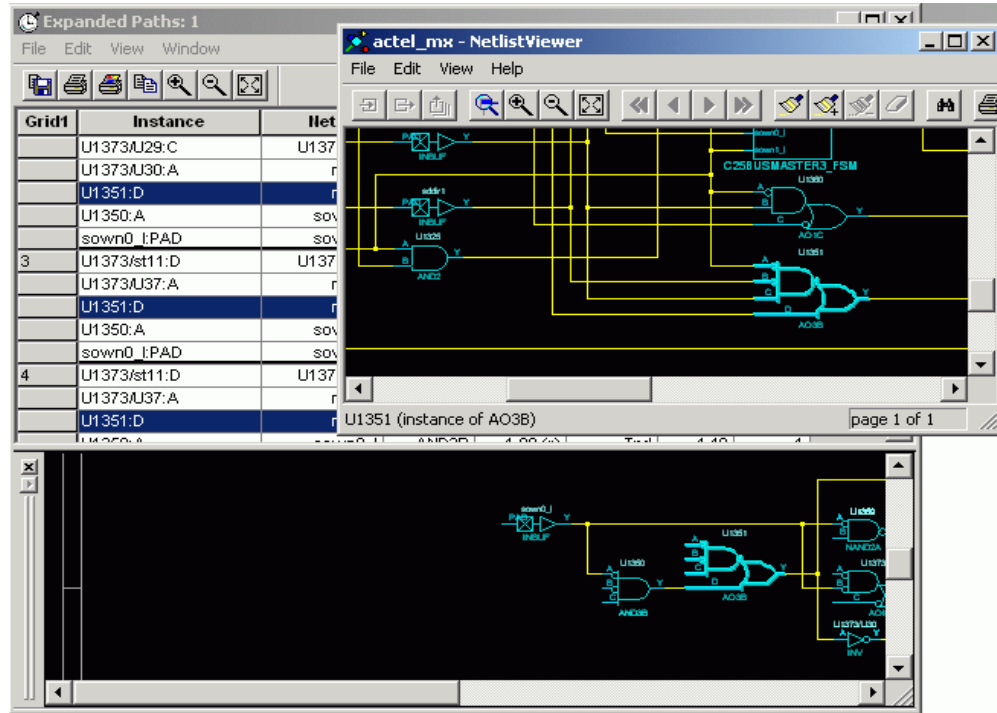

Selected Macro is Located and Selected in the NetlistViewer

Viewing Buffers

You can use NetlistViewer to see buffers inserted by your synthesis tool due to the high-fanout number of some signals.

To view inserted buffers, click **NetlistViewer** in the Design Flow window. NetlistViewer starts and displays your netlist.

In the following example, the fanout of DATAIN and RESETIN inputs of the design exceeds the specified value in the Synplicity synthesis tool. To reduce the number of fanout for these signals, Synplicity inserts two buffers in their path. You can use NetlistViewer to see these inserted buffers.

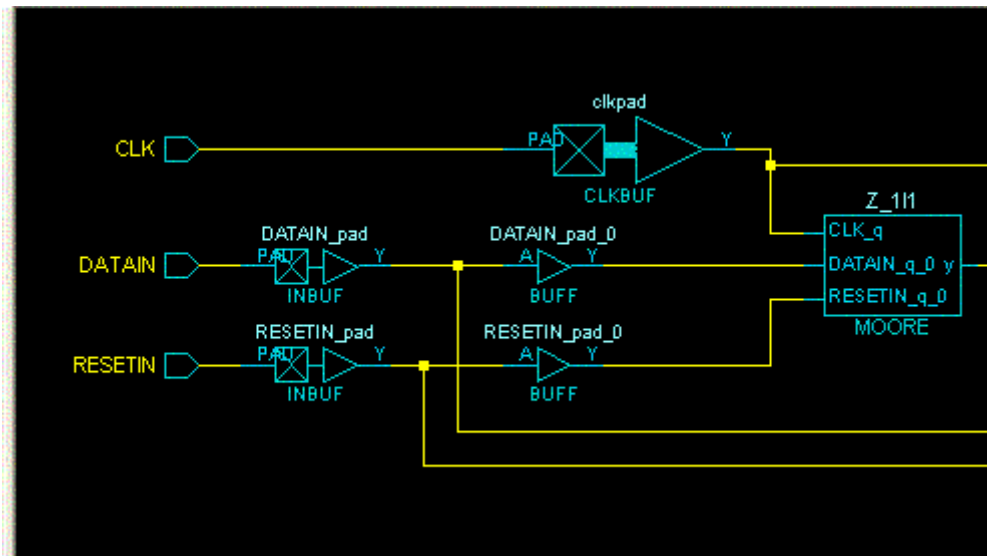

Inserted Buffers

Menus, Toolbar Buttons, and Shortcut Keys







The PC and workstation (UNIX) versions of NetlistViewer Standalone have the same menus. However, some dialog boxes may look slightly different due to the different windowing environments. The functionality is the same, though the locations of the fields and buttons on the dialog boxes may vary. Field names may also vary between platforms.

- File menu
- Edit menu
- View menu
- Help menu









File menu

Command	Icon	Shortcut	Function
Print		CTRL + P	Prints the display
Print Preview			Previews the display
Print Setup			Sets your printing options
Close		CTRL + S	Closes NetlistViewer

Edit menu

Commands	Icon	Shortcut	Function
Push		CTRL + P	Displays the next lower level in the design hierarchy
Pop		CTRL + O	Displays the next higher level in the design hierarchy
Top		CTRL + T	Displays the top level of the design hierarchy
Highlight			Marks the currently selected object by turning it red
Highlight Append			Highlights the currently selected object in red and adds it to a group, which includes that last highlighted object
Un-Highlight			Unmarks the selected object only, returning it to yellow or blue
Clear Highlight			Clears all marked objects, returning them to yellow or blue

View menu

Command	Icon	Shortcut	Function
Zoom Window			Drag out an area to enlarge
Zoom Fit			Fits the entire design in the Schematic view
Zoom In			Magnifies the view by a factor of 2 (scale = 2x)
Zoom Out			Reduces the view by a factor of 2 (scale = .5x)
Redraw			Redraws the screen
Go to First Page			Displays the first page of the current level of the design
Go to Previous Page			Displays the previous page of the current level of the design
Go to Next Page			Displays the next page of the current level of the design
Go to Last Page			Displays the last page of the current level of the design
Toolbar			Hides or displays groups of toolbar buttons
Search Tool			Hides or displays the Search window
Hierarchy			Hides or displays the Hierarchy window

Help menu

Command	Shortcut	Function
Help Topics		Displays the first Help topic for NetlistViewer, which provides you with an overview of the tool
Reference Manual		Opens the NetlistViewer User's Guide (.pdf file) in Adobe Acrobat

Contacting Actel

Actel Headquarters

Actel Corporation is a supplier of innovative programmable logic solutions, including field-programmable gate arrays (FPGAs) based on Antifuse and Flash technologies, high-performance intellectual property (IP) cores, software development tools, and design services targeted for the high-speed communications, application-specific integrated circuit (ASIC) replacement, and radiation-tolerant markets.

Address:	Actel Corporation 2061 Stierlin Court Mountain View CA 94043-4655 USA
Phone:	650.318.4200 650.318.4600

Technical Support

Highly skilled engineers staff the Technical Support Center from 7:00 A.M. to 6:00 P.M. Pacific Time, Monday through Friday.

Visit Tech Support Online

For 24-hour support resources, visit Actel Technical Support at <http://www.actel.com/custsup/search.html>.

Contacting Technical Support

Contact us with your technical questions via e-mail or by phone. When sending your request to us, please be sure to include your full name, company name, email address and telephone number.

E-mail (Worldwide):	tech@actel.com
Telephone (In U.S.):	(650) 318-4460 (800) 262-1060
Telephone (Outside the US):	Contact a local sales office

Customer Service

Contact Customer Service for order status, order expedites, return material authorizations (RMA), and first article processing. For technical issues, contact [Technical Support](#).

From	Call
Northeast and North Central U.S.A.	(650) 318-4480
Southeast and Southwest U.S.A.	(650) 318-4480
South Central U.S.A.	(650) 318-4434
Northwest U.S.A.	(650) 318-4434
Canada	(650) 318-4480
Europe	(650) 318-4252 or +44 (0) 1276 401500
Japan	(650) 318-4743
From the rest of the world	(650) 318-4743

For more information about Actel's products, call 888-99-CTEL or visit our Web site at <http://www.actel.com>

Actel Corporation • 2061 Stierlin Court • Mountain View, CA USA 94043

U.S. Toll Free Line: 888-99-CTEL • Customer Service: 650-318-4200 • Customer Service FAX: 650-318-2440

Customer Applications Center: 800-262-1060 • Customer Applications FAX: 650-318-4600

Actel Europe Ltd. • Dunlop House, Riverside Way • Camberley, Surrey GU15 3YL • United Kingdom Tel: +44 (0)1276 401 463 •
Fax: +44 (0)1276 401 490

Actel Japan • EXOS Ebisu Bldg. 4F • 1-24-14 Ebisu Shibuya-ku • Tokyo 150 • Japan

Tel: +81 (0)334-457-671 Fax: +81 (0)334-457-668

Actel Hong Kong International • 39th Floor • One Pacific Place • 88 Queensway, Admiralty • Hong Kong

Tel: +852.227.35712 Fax: +852.227.35999

5-02-9135-3

