

---

# ***Actel HDL Coding***

*Style Guide*



---

## **Actel Corporation, Mountain View, CA 94043**

© 2003 Actel Corporation. All rights reserved.

Printed in the United States of America

Part Number: 5029105-6/05.04

Release: May 2004

No part of this document may be copied or reproduced in any form or by any means without prior written consent of Actel.

Actel makes no warranties with respect to this documentation and disclaims any implied warranties of merchantability or fitness for a particular purpose. Information in this document is subject to change without notice. Actel assumes no responsibility for any errors that may appear in this document.

This document contains confidential proprietary information that is not to be disclosed to any unauthorized person without prior written consent of Actel Corporation.

### **Trademarks**

Actel and the Actel logo are registered trademarks of Actel Corporation.

Adobe and Acrobat Reader are registered trademarks of Adobe Systems, Inc.

All other products or brand names mentioned are trademarks or registered trademarks of their respective holders.

---

# Table of Contents

Introduction . . . . .	7
Document Organization . . . . .	7
Document Assumptions . . . . .	7
Document Conventions . . . . .	8
HDL Keywords and Naming Conventions . . . . .	8
VHDL . . . . .	8
Verilog . . . . .	9
Your Comments . . . . .	10
Actel Manuals . . . . .	11
Related Manuals . . . . .	12
Online Help . . . . .	13
<b>1 Design Flow . . . . .</b>	<b>15</b>
Design Flow Illustrated . . . . .	15
Design Flow Overview . . . . .	16
Design Creation/Verification . . . . .	16
Design Implementation . . . . .	17
Programming . . . . .	17
System Verification . . . . .	18
<b>2 Technology Independent Coding Styles . . . . .</b>	<b>19</b>
Sequential Devices . . . . .	19
Flip-Flops (Registers) . . . . .	19
D-Latches . . . . .	27
Operators . . . . .	31
Datapath . . . . .	33
Priority Encoders Using If-Then-Else . . . . .	33
Multiplexors Using Case . . . . .	34
Decoders . . . . .	39
Counters . . . . .	40
Arithmetic Operators . . . . .	44
Relational Operators . . . . .	45
Equality Operator . . . . .	46

Shift Operators . . . . .	48
Finite State Machine . . . . .	49
Mealy Machine . . . . .	51
Moore Machine . . . . .	55
Input-Output Buffers . . . . .	58
Tri-State Buffer . . . . .	59
Bi-Directional Buffer . . . . .	61
Generics and Parameters . . . . .	63
<b>3 Performance Driven Coding . . . . .</b>	<b>65</b>
Reducing Logic Levels on Critical Paths . . . . .	65
Example 1 . . . . .	65
Example 2 . . . . .	66
Resource Sharing . . . . .	68
Example 1 . . . . .	68
Example 2 . . . . .	68
Operators Inside Loops . . . . .	70
Coding for Combinability . . . . .	71
Register Duplication . . . . .	72
Partitioning a Design . . . . .	75
Registers Embedded Within a Module . . . . .	75
Registers Pushed Out at the Hierarchical Boundary . . . . .	76
<b>4 Technology Specific Coding Techniques . . . . .</b>	<b>77</b>
Multiplexors . . . . .	77
Internal Tri-State to Multiplexor Mapping . . . . .	77
Registers . . . . .	80
Synchronous Clear or Preset . . . . .	81
Clock Enabled . . . . .	82
Asynchronous Preset . . . . .	84
Asynchronous Preset and Clear . . . . .	86
Registered I/Os . . . . .	87
CLKINT/CLKBUF for Reset and/or High Fanout Networks . . . . .	88

QCLKINT/QCLKBUF for Medium Fanout Networks . . . . .	90
ACTgen Counter . . . . .	91
Dual Architecture Coding in VHDL . . . . .	92
RTL Architecture . . . . .	92
Structural Architecture . . . . .	93
Instantiating “CNT5” in the Top Level Design . . . . .	94
SRAM . . . . .	95
Register-Based Single Port SRAM . . . . .	95
Register-Based Dual-Port SRAM . . . . .	97
ACTgen RAM . . . . .	99
FIFO . . . . .	101
Register-Based FIFO . . . . .	101
ACTgen FIFO . . . . .	107
<b>A Product Support . . . . .</b>	<b>109</b>
Customer Service . . . . .	109
Actel Customer Technical Support Center . . . . .	109
Actel Technical Support . . . . .	109
Website . . . . .	109
Contacting the Customer Technical Support Center . . . . .	110
Email . . . . .	110
Phone . . . . .	110
<b>Index . . . . .</b>	<b>111</b>



---

# Introduction

VHDL and Verilog® HDL are high level description languages for system and circuit design. These languages support various abstraction levels of design, including architecture-specific design. At the higher levels, these languages can be used for system design without regard to a specific technology. To create a functional design, you only need to consider a specific target technology. However, to achieve optimal performance and area from your target device, you must become familiar with the architecture of the device and then code your design for that architecture.

Efficient, standard HDL code is essential for creating good designs. The structure of the design is a direct result of the structure of the HDL code. Additionally, standard HDL code allows designs to be reused in other designs or by other HDL designers.

This document provides the preferred coding styles for the Actel architecture. The information is reference material with instructions to optimize your HDL code for the Actel architecture. Examples in both VHDL and Verilog code are provided to illustrate these coding styles and to help implement the code into your design.

For further information about HDL coding styles, synthesis methodology, or application notes, please visit Actel's web site at the following URL: <http://www.actel.com/>

## Document Organization

The *Actel HDL Coding Style Guide* is divided into the following chapters:

**Chapter 1 - Design Flow** describes the basic design flow for creating Actel designs with HDL synthesis and simulation tools.

**Chapter 2 - Technology Independent Coding Styles** describes basic high level HDL coding styles and techniques.

**Chapter 3 - Performance Driven Coding** illustrates efficient design practices and describes synthesis implementations and techniques that can be used to reduce logic levels on a critical path.

**Chapter 4 - Technology Specific Coding Techniques** describes how to implement technology specific features and technology specific macros for optimal area and performance utilization.

**Appendix A - Product Support** provides information about contacting Actel for customer and technical support.

## Document Assumptions

The information in this manual is based on the following assumptions:

- You are familiar with Verilog or VHDL hardware description language, and HDL design methodology for designing logic circuits.

- You are familiar with FPGA design software, including design synthesis and simulation tools.

## Document Conventions

The following conventions are used throughout this manual.

Information input by the user follows this format:

```
keyboard input
```

The contents of a file follows this format:

```
file contents
```

HDL code appear as follows, with HDL keyword in bold:

```
entity actel is  
port (  
    a: in bit;  
    y: out bit);  
end actel;
```

Messages that are displayed on the screen appear as follows:

Screen Message

## HDL Keywords and Naming Conventions

There are naming conventions you must follow when writing Verilog or VHDL code. Additionally, Verilog and VHDL have reserved words that cannot be used for signal or entity names. This section lists the naming conventions and reserved keywords for each.

### VHDL

The following naming conventions apply to VHDL designs:

- VHDL is not case sensitive.
- Two dashes “--” are used to begin comment lines.
- Names can use alphanumeric characters and the underscore “\_” character.
- Names must begin with an alphabetic letter.
- You may not use two underscores in a row, or use an underscore as the last character in the name.



- Spaces are not allowed within names.
- Object names must be unique. For example, you cannot have a signal named A and a bus named A(7 **downto** 0).

The following is a list of the VHDL reserved keywords:

abs	downto	library	postponed	subtype
access	else	linkage	procedure	then
after	elsif	literal	process	to
alias	end	loop	pure	transport
all	entity	map	range	type
and	exit	mod	record	unaffected
architecture	file	nand	register	units
array	for	new	reject	until
assert	function	next	rem	use
attribute	generate	nor	report	variable
begin	generic	not	return	wait
block	group	null	rol	when
body	guarded	of	ror	while
buffer	if	on	select	with
bus	impure	open	severity	xnor
case	in	or	shared	xor
component	inertial	others	signal	
configuration	inout	out	sla	
constant	is	package	sra	
disconnect	label	port	srl	

## Verilog

The following naming conventions apply to Verilog HDL designs:

- Verilog is case sensitive.
- Two slashes “//” are used to begin single line comments. A slash and asterisk “/\*” are used to begin a multiple line comment and an asterisk and slash “\*/” are used to end a multiple line comment.
- Names can use alphanumeric characters, the underscore “\_” character, and the dollar “\$” character.
- Names must begin with an alphabetic letter or the underscore.
- Spaces are not allowed within names.

The following is a list of the Verilog reserved keywords:

always	endmodule	medium	reg	tranif0
and	endprimitive	module	release	tranif1
assign	endspecify	nand	repeat	tri
attribute	endtable	negedge	rnmos	tri0
begin	endtask	nmos	rpmos	tri1
buf	event	nor	rtran	triand
bufif0	for	not	rtranif0	trior
bufif1	force	notif0	rtranif1	trireg
case	forever	notif1	scalared	unsigned
casex	fork	or	signed	vectored
casez	function	output	small	wait
cmos	highz0	parameter	specify	wand
deassign	highz1	pmos	specparam	weak0
default	if	posedge	strength	weak1
defparam	ifnone	primitive	strong0	while
disable	initial	pull0	strong1	wire
edge	inout	pull1	supply0	wor
else	input	pulldown	supply1	xnor
end	integer	pullup	table	xor
endattribute	join	remos	task	
endcase	large	real	time	
endfunction	macromodule	realtime	tran	

## Your Comments

Actel Corporation strives to produce the highest quality online help and printed documentation. We want to help you learn about our products, so you can get your work done quickly. We welcome your feedback about this guide and our online help. Please send your comments to [documentation@actel.com](mailto:documentation@actel.com).

## Actel Manuals

Designer and Libero include printed and online manuals. The online manuals are in PDF format and available from Libero and Designer's Start Menus and on the CD-ROM. From the Start menu choose:

- Programs > Libero 2.2 > Libero 2.2 Documentation.
- Programs > Designer Series > R1-2002 Documentation

Also, the online manuals are in PDF format on the CD-ROM in the "/manuals" directory. These manuals are also installed onto your system when you install the Designer software. To view the online manuals, you must install Adobe® Acrobat Reader® from the CD-ROM.

The Designer Series includes the following manuals, which provide additional information on designing Actel FPGAs:

*Getting Started User's Guide.* This manual contains information for using the Designer Series Development System software to create designs for, and program, Actel devices.

*Designer User's Guide.* This manual provides an introduction to the Designer series software as well as an explanation of its tools and features.

*PinEdit User's Guide.* This guide provides a detailed description of the PinEdit tool in Designer. It includes cross-platform explanations of all the PinEdit features.

*ChipEdit User's Guide.* This guide provides a detailed description of the ChipEdit tool in Designer. It includes a detailed explanation of the ChipEdit functionality.

*Timer User's Guide.* This guide provides a detailed description of the Timer tool in Designer. It includes a detailed explanation of the Timer functionality.

*SmartPower User's Guide.* This guide provides a detailed description of using the SmartPower tool to perform power analysis.

*Netlist Viewer User's Guide.* This guide provides a detailed description of the Netlist Viewer. Information on using the Netlist Viewer with Timer and ChipEdit to debug your netlist is provided.

*A Guide to ACTgen Macros.* This Guide provides descriptions of macros that can be generated using the Actel ACTgen Macro Builder software.

*Actel HDL Coding Style Guide.* This guide provides preferred coding styles for the Actel architecture and information about optimizing your HDL code for Actel devices.

*Silicon Expert User's Guide.* This guide contains information to assist designers in the use of Actel's Silicon Expert tool.

*Cadence<sup>®</sup> Interface Guide.* This guide contains information to assist designers in the design of Actel devices using Cadence CAE software and the Designer Series software.

*Mentor Graphics<sup>®</sup> Interface Guide.* This guide contains information to assist designers in the design of Actel devices using Mentor Graphics CAE software and the Designer Series software.

*Synopsys<sup>®</sup> Synthesis Methodology Guide.* This guide contains preferred HDL coding styles and information to assist designers in the design of Actel devices using Synopsys CAE software and the Designer Series software.

*Innoveda<sup>®</sup> eProduct Designer Interface Guide (Windows).* This guide contains information to assist designers in the design of Actel devices using eProduct Designer CAE software and the Designer Series software.

*VHDL Vital Simulation Guide.* This guide contains information to assist designers in simulating Actel designs using a Vital compliant VHDL simulator.

*Verilog Simulation Guide.* This guide contains information to assist designers in simulating Actel designs using a Verilog simulator.

*Activator and APS Programming System*

*Installation and User's Guide.* This guide contains information about how to program and debug Actel devices, including information about using the Silicon Explorer diagnostic tool for system verification.

*Silicon Sculptor User's Guide.* This guide contains information about how to program Actel devices using the Silicon Sculptor software and device programmer.

*Flash Pro User's Guide.* This guide contains information about how to program Actel ProASIC and ProASIC<sup>PLUS</sup> devices using the Flash Pro software and device programmer.

*Silicon Explorer II.* This guide contains information about connecting the Silicon Explorer diagnostic tool and using it to perform system verification.

*Macro Library Guide.* This guide provides descriptions of Actel library elements for Actel device families. Symbols, truth tables, and module count are included for all macros.

*ProASIC<sup>PLUS</sup> Macro Library Guide.* This guide provides descriptions of Actel library elements for Actel ProASIC and ProASIC<sup>PLUS</sup> device families. Symbols, truth tables, and tile usage are included for all macros.

## Related Manuals

The following manuals provide additional information about designing and programming Actel FPGAs using HDL design methodology:

*Digital Design and Synthesis with Verilog HDL*. Madhavan, Rajeev, and others. San Jose, CA: Automata Publishing Company, 1993. This book contains information to allow designers to write synthesizable designs with Verilog HDL.

*HDL Chip Design*. Smith, Douglas J. Madison, AL: Doone Publications, 1996. This book describes and gives examples of how to design FPGAs using VHDL and Verilog.

*IEEE Standard VHDL Language Reference Manual*. New York: Institute of Electrical and Electronics Engineers, Inc., 1994. This manual specifies IEEE Standard 1076-1993, which defines the VHDL standard and the use of VHDL in the creation of electronic systems.

## Online Help

The Designer Series software comes with online help. Online help specific to each software tool is available in Libero, Designer, ACTgen, ACTmap, Silicon Expert, Silicon Explorer II, Silicon Sculptor, and APSW.



# Design Flow

This chapter illustrates and describes the basic design flow for creating Actel designs using HDL synthesis and simulation tools.

## Design Flow Illustrated

Figure 1-1 illustrates the HDL synthesis-based design flow for an Actel FPGA using third party CAE tools and Designer software<sup>1</sup>.

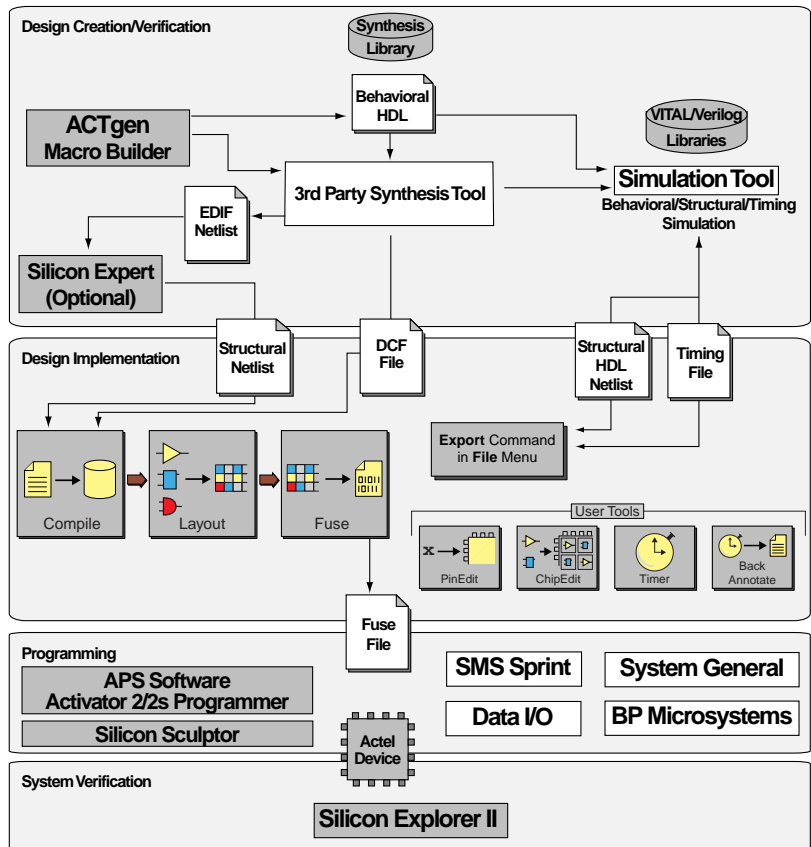

Figure 1-1. Actel HDL Synthesis-Based Design Flow

## Design Flow Overview

The Actel HDL synthesis-based design flow has four main steps: design creation/verification, design implementation, programming, and system verification. These steps are described in detail in the following sections.

### Design Creation/Verification

During design creation/verification, a design is captured in an RTL-level (behavioral) HDL source file. After capturing the design, a behavioral simulation of the HDL file can be performed to verify that the HDL code is correct. The code is then synthesized into an Actel gate-level (structural) HDL netlist. After synthesis, a structural simulation of the design can be performed. Finally, an EDIF netlist is generated for use in Designer and an HDL structural netlist is generated for timing simulation.

#### HDL Design Source Entry

Enter your HDL design source using a text editor or a context-sensitive HDL editor. Your HDL source file can contain RTL-level constructs, as well as instantiations of structural elements, such as ACTgen macros.

#### Behavioral Simulation

You can perform a behavioral simulation of your design before synthesis. Behavioral simulation verifies the functionality of your HDL code. Typically, unit delays are used and a standard HDL test bench can be used to drive simulation. Refer to the documentation included with your simulation tool for information about performing behavioral simulation.

#### Synthesis

After you have created your behavioral HDL source file, you must synthesize it before placing and routing it in Designer. Synthesis translates the behavioral HDL file into a gate-level netlist and optimizes the design for a target technology. Refer to the documentation included with your synthesis tool for information about performing design synthesis.

#### Netlist Generation

After you have created, synthesized, and verified your design, you may place-and-route in Designer using an EDIF, Verilog, or VHDL netlist. This netlist is also used to generate a structural HDL netlist for use in structural simulation. Refer to the Designer Series documentation for information about generating a netlist.

---

*1. Actel-specific utilities/tools are denoted by grey boxes in Figure 1-1.*



## Structural Netlist Generation

You can generate a structural HDL netlist from your EDIF netlist for use in structural simulation by either exporting it from Designer or by using the Actel “edn2vhdl” or “edn2vlog” program. Refer to the Designer Series documentation for information about generating a structural netlist.

## Structural Simulation

You can perform a structural simulation of your design before placing and routing it. Structural simulation verifies the functionality of your post-synthesis structural HDL netlist. Default unit delays included in the compiled Actel VITAL libraries are used for every gate. Refer to the documentation included with your simulation tool for information about performing structural simulation.

## Design Implementation

During design implementation, a design is placed-and-routed using Designer. Additionally, timing analysis is performed on a design in Designer with the Timer tool. After place-and-route, post-layout (timing) simulation is performed.

### Place-and-Route

Use Designer to place-and-route your design. Refer to the Designer Series documentation for information about using Designer.

### Timing Analysis

Use the Timer tool in Designer to perform static timing analysis on your design. Refer to the *Timer User's Guide* for information about using Timer.

### Timing Simulation

After placing-and-routing your design, you perform a timing simulation to verify that the design meets timing constraints. Timing simulation requires timing information exported from Designer, which overrides default unit delays in the compiled Actel VITAL libraries. Refer to the Designer Series documentation for information about exporting timing information from Designer.

## Programming

Programming a device requires software and hardware from Actel or a supported 3rd party programming system. Refer to the *Getting Started User's Guide*, the *Using Designer* manual, and the *Activator Installation and APS Programming Guide* for information on programming an Actel device.

## **System Verification**

You can perform system verification on a programmed device using Actel's Silicon Explorer. Refer to the *Activator Installation and APS Programming Guide* or *Silicon Explorer II Quick Start* for information on using Silicon Explorer.

# Technology Independent Coding Styles

This chapter describes basic HDL coding styles and techniques. These coding styles are essential when writing efficient, standard HDL code and creating technology independent designs.

## Sequential Devices

A sequential device, either a flip-flop or a latch, is a one-bit memory device. A latch is a level-sensitive memory device and a flip-flop is an edge-triggered memory device.

### Flip-Flops (Registers)

Flip-flops, also called registers, are inferred in VHDL using wait and if statements within a process using either a rising edge or falling edge detection expression. There are two types of expressions that can be used, a 'event attribute or a function call. For example:

```
(clk'event and clk='1')      --rising edge 'event attribute
(clk'event and clk='0')      --falling edge 'event attribute
rising_edge(clock)           --rising edge function call
falling_edge(clock)          --falling edge function call
```

The examples in this guide use rising edge 'event attribute expressions, but falling edge expressions could be used. The 'event attribute expression is used because some VHDL synthesis tools may not recognize function call expressions. However, using a function call expression is preferred for simulation because a function call only detects an edge transition (0 to 1 or 1 to 0) but not a transition from X to 1 or 0 to X, which may not be a valid transition. This is especially true if using a multi-valued data type like `std_logic`, which has nine possible values (U, X, 0, 1, Z, W, L, H, -).

This section describes and gives examples for different types of flip-flops. Refer to [“Registers” on page 80](#) for additional information about using specific registers in the Actel architecture.

#### Rising Edge Flip-Flop

The following examples infer a D flip-flop without asynchronous or synchronous reset or preset. This flip-flop is a basic sequential cell in the Actel antifuse architecture.

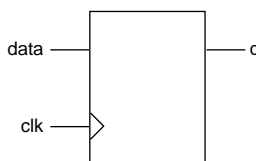

Figure 2-2. D Flip Flop

### VHDL

```
library IEEE;
use IEEE.std_logic_1164.all;

entity dff is
port (data, clk : in std_logic;
      q : out std_logic);
end dff;

architecture behav of dff is
begin
process (clk) begin
    if (clk'event and clk = '1') then
        q <= data;
    end if;
end process;
end behav;
```

### Verilog

```
module dff (data, clk, q);
    input data, clk;
    output q;
    reg q;
    always @(posedge clk)
        q = data;
endmodule
```

## Rising Edge Flip-Flop with Asynchronous Reset

The following examples infer a D flip-flop with an asynchronous reset. This flip-flop is a basic sequential cell in the Actel antifuse architecture.

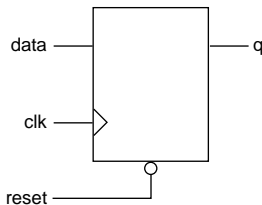

Figure 2-3. D Flip-Flop with Asynchronous Reset

### VHDL

```
library IEEE;
use IEEE.std_logic_1164.all;

entity dff_async_rst is
port (data, clk, reset : in std_logic;
      q : out std_logic);
end dff_async_rst;

architecture behav of dff_async_rst is
begin
process (clk, reset) begin
    if (reset = '0') then
        q <= '0';
    elsif (clk'event and clk = '1') then
        q <= data;
    end if;
end process;
end behav;
```

### Verilog

```
module dff_async_rst (data, clk, reset, q);
    input data, clk, reset;
    output q;
    reg q;
    always @(posedge clk or negedge reset)
        if (~reset)
            q = 1'b0;
        else
            q = data;
endmodule
```

## Rising Edge Flip-Flop with Asynchronous Preset

The following examples infer a D flip-flop with an asynchronous preset. Refer to “[Registers](#)” on [page 80](#) for additional information about using preset flip-flops with the Actel architecture.

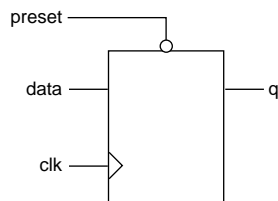

Figure 2-4. D Flip-Flop with Asynchronous Preset

### ***VHDL***

```
library IEEE;
use IEEE.std_logic_1164.all;

entity dff_async_pre is
port (data, clk, preset : in std_logic;
      q : out std_logic);
end dff_async_pre;

architecture behav of dff_async_pre is
begin
process (clk, preset) begin
    if (preset = '0') then
        q <= '1';
    elsif (clk'event and clk = '1') then
        q <= data;
    end if;
end process;
end behav;
```

### ***Verilog***

```
module dff_async_pre (data, clk, preset, q);
input data, clk, preset;
output q;
reg q;
always @(posedge clk or negedge preset)
    if (~preset)
        q = 1'b1;
    else
        q = data;
endmodule
```

## Rising Edge Flip-Flop with Asynchronous Reset and Preset

The following examples infer a D flip-flop with an asynchronous reset and preset. Refer to “Registers” on page 80 for additional information about using preset flip-flops with the Actel architecture.

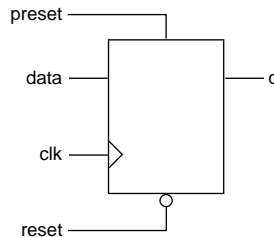

Figure 2-5. D Flip-Flop

### VHDL

```

library IEEE;
use IEEE.std_logic_1164.all;

entity dff_async is
port (data, clk, reset, preset : in std_logic;
      q : out std_logic);
end dff_async;

architecture behav of dff_async is
begin
process (clk, reset, preset) begin
  if (reset = '0') then
    q <= '0';
  elsif (preset = '1') then
    q <= '1';
  elsif (clk'event and clk = '1') then
    q <= data;
  end if;
end process;
end behav;

```

### Verilog

```

module dff_async (reset, preset, data, q, clk);
input clk;
input reset, preset, data;
output q;
reg q;

```

```
always @ (posedge clk or negedge reset or posedge preset)
  if (~reset)
    q = 1'b0;
  else if (preset)
    q = 1'b1;
  else q = data;
endmodule
```

## Rising Edge Flip-Flop with Synchronous Reset

The following examples infer a D flip-flop with a synchronous reset.

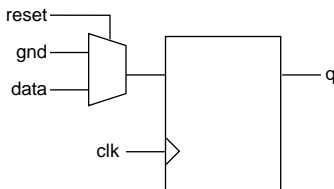

Figure 2-6. D Flip-Flop with Synchronous Reset

### VHDL

```
library IEEE;
use IEEE.std_logic_1164.all;

entity dff_sync_rst is
  port (data, clk, reset : in std_logic;
        q : out std_logic);
end dff_sync_rst;

architecture behav of dff_sync_rst is
begin
  process (clk) begin
    if (clk'event and clk = '1') then
      if (reset = '0') then
        q <= '0';
      else q <= data;
      end if;
    end if;
  end process;
end behav;
```

### Verilog

```
module dff_sync_rst (data, clk, reset, q);
```



```

        input data, clk, reset;
        output q;
        reg q;
    always @ (posedge clk)
        if (~reset)
            q = 1'b0;
        else q = data;
    endmodule
    
```

## Rising Edge Flip-Flop with Synchronous Preset

The following examples infer a D flip-flop with a synchronous preset.

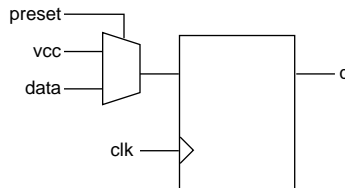

Figure 2-7. D Flip-Flop with Synchronous Preset

### VHDL

```

library IEEE;
use IEEE.std_logic_1164.all;

entity dff_sync_pre is
    port (data, clk, preset : in std_logic;
          q : out std_logic);
end dff_sync_pre;

architecture behav of dff_sync_pre is
begin
    process (clk) begin
        if (clk'event and clk = '1') then
            if (preset = '0') then
                q <= '1';
            else q <= data;
            end if;
        end if;
    end process;
end behav;
    
```

### Verilog

```

module dff_sync_pre (data, clk, preset, q);
    
```

```
    input data, clk, preset;
    output q;
    reg q;
always @ (posedge clk)
    if (~preset)
        q = 1'b1;
    else q = data;
endmodule
```

## Rising Edge Flip-Flop with Asynchronous Reset and Clock Enable

The following examples infer a D type flip-flop with an asynchronous reset and clock enable.

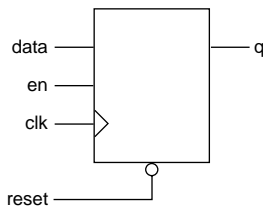

Figure 2-8. D Flip-Flop

### VHDL

```
library IEEE;
use IEEE.std_logic_1164.all;

entity dff_ck_en is
port (data, clk, reset, en : in std_logic;
      q : out std_logic);
end dff_ck_en;

architecture behav of dff_ck_en is
begin
process (clk, reset) begin
    if (reset = '0') then
        q <= '0';
    elsif (clk'event and clk = '1') then
        if (en = '1') then
            q <= data;
        end if;
    end if;
end process;
end behav;
```

### Verilog

```
module dff_ck_en (data, clk, reset, en, q);
    input data, clk, reset, en;
    output q;
```

```

    reg q;
always @ (posedge clk or negedge reset)
    if (~reset)
        q = 1'b0;
    else if (en)
        q = data;
endmodule

```

## D-Latches

This section describes and gives examples of different types of D-latches.

### D-Latch with Data and Enable

The following examples infer a D-latch with data and enable inputs.

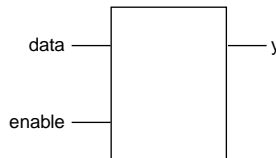

Figure 2-9. D-Latch

#### VHDL

```

library IEEE;
use IEEE.std_logic_1164.all;

entity d_latch is
port(enable, data: in std_logic;
      y : out std_logic);
end d_latch;

architecture behave of d_latch is
begin
process (enable, data)
begin
    if (enable = '1') then
        y <= data;
    end if;
end process;
end behave;

```

#### Verilog

```

module d_latch (enable, data, y);

```

```
    input enable, data;
    output y;
    reg y;
always @(enable or data)
    if (enable)
        y = data;
endmodule
```

## D-Latch with Gated Asynchronous Data

The following examples infer a D-latch with gated asynchronous data.

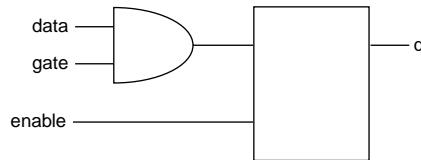

Figure 2-10. D-Latch with Gated Asynchronous Data

### VHDL

```
library IEEE;
use IEEE.std_logic_1164.all;

entity d_latch_e is
port (enable, gate, data : in std_logic;
      q : out std_logic);
end d_latch_e;

architecture behave of d_latch_e is
begin
process (enable, gate, data) begin
    if (enable = '1') then
        q <= data and gate;
    end if;
end process;
end behave;
```

### Verilog

```
module d_latch_e(enable, gate, data, q);
    input enable, gate, data;
    output q;
    reg q;
```

```

always @ (enable or data or gate)
  if (enable)
    q = (data & gate);
endmodule

```

## D-Latch with Gated Enable

The following examples infer a D-latch with gated enable.

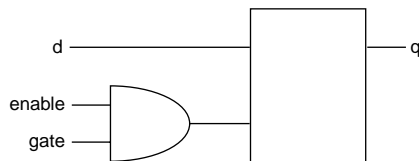

Figure 2-11. D-Latch with Gated Enable

### VHDL

```

library IEEE;
use IEEE.std_logic_1164.all;

entity d_latch_en is
port (enable, gate, d: in std_logic;
      q : out std_logic);
end d_latch_en;

architecture behave of d_latch_en is
begin
process (enable, gate, d) begin
  if ((enable and gate) = '1') then
    q <= d;
  end if;
end process;
end behave;

```

### Verilog

```

module d_latch_en(enable, gate, d, q);
  input enable, gate, d;
  output q;
  reg q;
  always @ (enable or d or gate)
    if (enable & gate)

```

```
    q = d;  
endmodule
```

## D-Latch with Asynchronous Reset

The following examples infer a D-latch with an asynchronous reset.

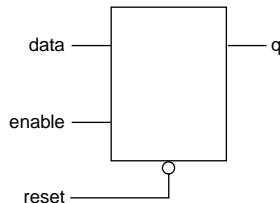

Figure 2-12. D-Latch

### VHDL

```
library IEEE;  
use IEEE.std_logic_1164.all;  
  
entity d_latch_rst is  
port (enable, data, reset: in std_logic;  
      q      : out std_logic);  
end d_latch_rst;  
  
architecture behav of d_latch_rst is  
begin  
process (enable, data, reset) begin  
    if (reset = '0') then  
        q <= '0';  
    elsif (enable = '1') then  
        q <= data;  
    end if;  
end process;  
end behav;
```

### Verilog

```
module d_latch_rst (reset, enable, data, q);  
    input reset, enable, data;  
    output q;  
    reg q;  
    always @ (reset or enable or data)  
        if (~reset)  
            q = 1'b0;
```

```

    else if (enable)
      q = data;
    endmodule
  
```

## Operators

A number of bit-wise operators are available to you: Arithmetic, Concentration and Replication, Conditional, Equality, Logical Bit-wise, Logical Comparison, Reduction, Relational, Shift, and Unary Arithmetic (Sign). These operators and their availability in VHDL or Verilog are compared in [Table 2-1](#).

Table 2-1. VHDL and Verilog Operators

Operation	Operator	
	VHDL	Verilog
Arithmetic Operators		
exponential	**	
multiplication	*	*
division	/	/
addition	+	+
subtraction	-	-
modulus	mod	%
remainder	rem	
absolute value	abs	
Concentration and Replication Operators		
concentration	&c	{ }
replication		{ { }
Conditional Operator		
conditional		?:
Equality Operators		
equality	=	==
inequality	/=	!=

Table 2-1. VHDL and Verilog Operators (Continued)

Operation	Operator	
	VHDL	Verilog
Logical Bit-wise Operators unary negation NOT binary AND binary OR binary NAND binary NOR binary XOR binary XNOR	not and or nand nor xor xnor	~ &   ^ ^~ or ~^
Logical Comparison Operators NOT AND OR	not and or	! && 
Reduction Operators AND OR NAND NOR XOR XNOR		&   ~& ~  ^ ^~ or ~^
Relational Operators less than less than or equal to greater than greater than or equal to	< <= > >=	< <= > >=
Shift Operators logical shift left logical shift right arithmetic shift left arithmetic shift right logical rotate left logical rotate right	sll srl sla sra rol ror	<< >>
Unary Arithmetic Operators identity negotation	+ -	+ -



# Datapath

Datapath logic is a structured repetitive function. These structures are modeled in various different implementations based on area and timing constraints. Most synthesis tools generate optimal implementations for the target technology.

## Priority Encoders Using If-Then-Else

An if-then-else statement is used to conditionally execute sequential statements based on a value. Each condition of the if-then-else statement is checked in order against that value until a true condition is found. Statements associated with the true condition are then executed and the rest of the statement is ignored. If-then-else statements should be used to imply priority on a late arriving signal. In the following examples, shown in [Figure 2-13](#), signal c is a late arriving signal.

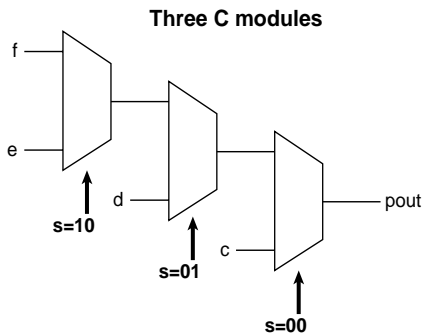

Figure 2-13. Priority Encoder Using an If-Then-Else Statement

### VHDL

```

library IEEE;
use IEEE.std_logic_1164.all;

entity my_if is
port (c, d, e, f: in std_logic;
      s      : in std_logic_vector(1 downto 0);
      pout  : out std_logic);
end my_if;

architecture my_arc of my_if is
begin
myif_pro: process (s, c, d, e, f) begin
  if s = "00" then

```

```
        pout <= c;
    elseif s = "01" then
        pout <= d;
    elseif s = "10" then
        pout <= e;
    else pout <= f;
    end if;
end process myif_pro;
end my_arc;
```

### *Verilog*

```
module IF_MUX (c, d, e, f, s, pout);
    input c, d, e, f;
    input [1:0]s;
    output pout;
    reg pout;
    always @(c or d or e or f or s) begin
        if (s == 2'b00)
            pout = c;
        else if (s ==2'b01)
            pout = d;
        else if (s ==2'b10)
            pout = e;
        else pout = f;
    end
endmodule
```

## Multiplexors Using Case

A case statement implies parallel encoding. Use a case statement to select one of several alternative statement sequences based on the value of a condition. The condition is checked against each choice in the case statement until a match is found. Statements associated with the matching choice are then executed. The case statement must include all possible values for a condition or have a default choice to be executed if none of the choices match. The following examples infer multiplexors using a case statement. Refer to [“Multiplexors” on page 77](#) for additional information about using multiplexors with the Actel architecture.

VHDL synthesis tools automatically assume parallel operation without priority in case statements. However, some Verilog tools assume priority, and you may need to add a directive to your case

statement to ensure that no priority is assumed. refer to the documentation provided with your synthesis tool for information about creating case statements without priority.

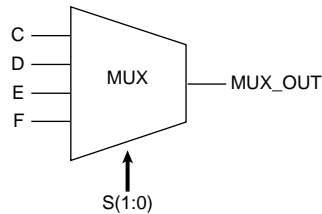

Figure 2-14. Multiplexor Using a Case Statement

## 4:1 Multiplexor

The following examples infer a 4:1 multiplexor using a case statement.

### VHDL

```
--4:1 Multiplexor
library IEEE;
use IEEE.std_logic_1164.all;

entity mux is
port (C, D, E, F : in std_logic;
      S           : in std_logic_vector(1 downto 0);
      mux_out     : out std_logic);
end mux;

architecture my_mux of mux is
begin
mux1: process (S, C, D, E, F) begin
  case s is
    when "00" => muxout <= C;
    when "01" => muxout <= D;
    when "10" => muxout <= E;
    when others => muxout <= F;
  end case;
end process mux1;
end my_mux;
```

### Verilog

```
//4:1 Multiplexor
module MUX (C, D, E, F, S, MUX_OUT);
  input C, D, E, F;
  input [1:0] S;
endmodule
```

```
        output MUX_OUT;
        reg MUX_OUT;
    always @(C or D or E or F or S)
    begin
        case (S)
            2'b00 : MUX_OUT = C;
            2'b01 : MUX_OUT = D;
            2'b10 : MUX_OUT = E;
            default : MUX_OUT = F;
        endcase
    end
endmodule
```

## 12:1 Multiplexor

The following examples infer a 12:1 multiplexor using a case statement.

### *VHDL*

```
-- 12:1 mux
library ieee;
use ieee.std_logic_1164.all;

-- Entity declaration:
entity mux12_1 is
port
(
    mux_sel:    in std_logic_vector (3 downto 0);-- mux select
    A:         in std_logic;
    B:         in std_logic;
    C:         in std_logic;
    D:         in std_logic;
    E:         in std_logic;
    F:         in std_logic;
    G:         in std_logic;
    H:         in std_logic;
    I:         in std_logic;
    J:         in std_logic;
    K:         in std_logic;
    M:         in std_logic;
    mux_out:   out std_logic -- mux output
);
end mux12_1;

-- Architectural body:
architecture synth of mux12_1 is

begin
```

```

proc1: process (mux_sel, A, B, C, D, E, F, G, H, I, J, K, M)
begin

case mux_sel is
  when "0000"      => mux_out<= A;
  when "0001"      => mux_out <= B;
  when "0010"      => mux_out <= C;
  when "0011"      => mux_out <= D;
  when "0100"      => mux_out <= E;
  when "0101"      => mux_out <= F;
  when "0110"      => mux_out <= G;
  when "0111"      => mux_out <= H;
  when "1000"      => mux_out <= I;
  when "1001"      => mux_out <= J;
  when "1010"      => mux_out <= K;
  when "1011"      => mux_out <= M;
  when others      => mux_out<= '0';

end case;
end process proc1;

end synth;

```

### *Verilog*

```

// 12:1 mux
module mux12_1(mux_out,
               mux_sel,M,L,K,J,H,G,F,E,D,C,B,A
               );

output        mux_out;
input         [3:0] mux_sel;
input         M;
input         L;
input         K;
input         J;
input         H;
input         G;
input         F;
input         E;
input         D;
input         C;
input         B;
input         A;

reg           mux_out;

```

```
// create a 12:1 mux using a case statement
always @ ({mux_sel[3:0]} or M or L or K or J or H or G or F or E or D or C
or B or A)
  begin: mux_blk
    case ({mux_sel[3:0]}) // synthesis full_case parallel_case
      4'b0000 : mux_out = A;
      4'b0001 : mux_out = B;
      4'b0010 : mux_out = C;
      4'b0011 : mux_out = D;
      4'b0100 : mux_out = E;
      4'b0101 : mux_out = F;
      4'b0110 : mux_out = G;
      4'b0111 : mux_out = H;
      4'b1000 : mux_out = J;
      4'b1001 : mux_out = K;
      4'b1010 : mux_out = L;
      4'b1011 : mux_out = M;
      4'b1100 : mux_out = 1'b0;
      4'b1101 : mux_out = 1'b0;
      4'b1110 : mux_out = 1'b0;
      4'b1111 : mux_out = 1'b0;
    endcase
  end
endmodule
```

## Case X Multiplexor

The following Verilog example infers a multiplexor using a don't care case x statement. Actel does not recommend using don't care case x statements in VHDL. VHDL synthesis tools do not typically support the don't care value as well as Verilog tools.

### *Verilog*

```
//8 bit 4:1 multiplexor with don't care X, 3:1 equivalent mux
module mux4 (a, b, c, sel, q);
input [7:0] a, b, c;
input [1:0] sel;
output [7:0] q;
reg [7:0] q;

always @ (sel or a or b or c)
casex (sel)
  2'b00: q = a;
  2'b01: q = b;
  2'bx: q = c;
  default: q = c;
endcase
```

```
endmodule
```

## Decoders

Decoders are used to decode data that has been previously encoded using binary or another type of encoding. The following examples infer a 3-8 line decoder with an enable.

### *VHDL*

```
library IEEE;
use IEEE.std_logic_1164.all;

entity decode is
    port ( Ain : in std_logic_vector (2 downto 0);
          En: in std_logic;
          Yout : out std_logic_vector (7 downto 0));
end decode;

architecture decode_arch of decode is
begin
    process (Ain)
    begin
        if (En='0') then
            Yout <= (others => '0');
        else
            case Ain is
                when "000" => Yout <= "00000001";
                when "001" => Yout <= "00000010";
                when "010" => Yout <= "00000100";
                when "011" => Yout <= "00001000";
                when "100" => Yout <= "00010000";
                when "101" => Yout <= "00100000";
                when "110" => Yout <= "01000000";
                when "111" => Yout <= "10000000";
                when others => Yout <= "00000000";
            end case;
        end if;
    end process;
end decode_arch;
```

### *Verilog*

```
module decode (Ain, En, Yout);
    input En;
    input [2:0] Ain;
    output [7:0] Yout;
```

```
        reg [7:0] Yout;

always @ (En or Ain)
begin
    if (!En)
        Yout = 8'b0;
    else
        case (Ain)
            3'b000 : Yout = 8'b00000001;
            3'b001 : Yout = 8'b00000010;
            3'b010 : Yout = 8'b00000100;
            3'b011 : Yout = 8'b00001000;
            3'b100 : Yout = 8'b00010000;
            3'b101 : Yout = 8'b00100000;
            3'b110 : Yout = 8'b01000000;
            3'b111 : Yout = 8'b10000000;
            default : Yout = 8'b00000000;
        endcase
    end
endmodule
```

## Counters

Counters count the number of occurrences of an event that occur either randomly or at uniform intervals. You can infer a counter in your design. However, most synthesis tools cannot infer optimal implementations of counters higher than 8-bits. If your counter is in the critical path of a speed and area critical design, Actel recommends that you use the ACTgen Macro Builder to build a counter. Once generated, instantiate the ACTgen counter in your design. Refer to [“ACTgen Counter” on page 91](#) for examples of ACTgen counter instantiation. The following examples infer different types of counters.

### 8-bit Up Counter with Count Enable and Asynchronous Reset

The following examples infer an 8-bit up counter with count enable and asynchronous reset.

#### *VHDL*

```
library IEEE;
use IEEE.std_logic_1164.all;
use IEEE.std_logic_unsigned.all;
use IEEE.std_logic_arith.all;

entity counter8 is
port (clk, en, rst      : in std_logic;
      count            : out std_logic_vector (7 downto 0));
end counter8;
```



```

architecture behave of counter8 is
signal cnt: std_logic_vector (7 downto 0);
begin
process (clk, en, cnt, rst)
begin
if (rst = '0') then
cnt <= (others => '0');
elsif (clk'event and clk = '1') then
if (en = '1') then
cnt <= cnt + '1';
end if;
end process;
count <= cnt;
end behave;

```

### *Verilog*

```

module count_en (en, clock, reset, out);
parameter Width = 8;
input clock, reset, en;
output [Width-1:0] out;
reg [Width-1:0] out;

always @(posedge clock or negedge reset)
if(!reset)
out = 8'b0;
else if(en)
out = out + 1;
endmodule

```

## 8-bit Up Counter with Load and Asynchronous Reset

The following examples infer an 8-bit up counter with load and asynchronous reset.

### *VHDL*

```

library IEEE;
use IEEE.std_logic_1164.all;
use IEEE.std_logic_unsigned.all;
use IEEE.std_logic_arith.all;

entity counter is
port (clk, reset, load: in std_logic;
data: in std_logic_vector (7 downto 0);
count: out std_logic_vector (7 downto 0));
end counter;

architecture behave of counter is
signal count_i : std_logic_vector (7 downto 0);
begin

```

```
process (clk, reset)
begin
  if (reset = '0') then
    count_i <= (others => '0');
  elsif (clk'event and clk = '1') then
    if load = '1' then
      count_i <= data;
    else
      count_i <= count_i + '1';
    end if;
  end if;
end process;
count <= count_i;
end behave;
```

### *Verilog*

```
module count_load (out, data, load, clk, reset);
  parameter Width = 8;
  input load, clk, reset;
  input [Width-1:0] data;
  output [Width-1:0] out;
  reg [Width-1:0] out;

  always @(posedge clk or negedge reset)
    if(!reset)
      out = 8'b0;
    else if(load)
      out = data;
    else
      out = out + 1;
endmodule
```

## 8-bit Up Counter with Load, Count Enable, Terminal Count and Asynchronous Reset

The following examples infer an 8-bit up counter with load, count enable, terminal count, and asynchronous reset.

### *Verilog*

```
module count_load (out, cout, data, load, clk, en, reset);
  parameter Width = 8;
  input load, clk, en, reset;
  input [Width-1:0] data;
  output cout; // carry out
  output [Width-1:0] out;
  reg [Width-1:0] out;

  always @(posedge clk or negedge reset)
    if(!reset)
```

```

        out = 8'b0;
    else if(load)
        out = data;
    else if(en)
        out = out + 1;
    // cout=1 when all out bits equal 1
    assign cout = &out;

endmodule

```

## N-bit Up Counter with Load, Count Enable, and Asynchronous Reset

The following examples infer an n-bit up counter with load, count enable, and asynchronous reset.

### VHDL

```

library IEEE;
use IEEE.std_logic_1164.all;
use IEEE.std_logic_unsigned.all;
use IEEE.std_logic_arith.all;

entity counter is
generic (width : integer := n);
port (data : in std_logic_vector (width-1 downto 0);
      load, en, clk, rst : in std_logic;
      q : out std_logic_vector (width-1 downto 0));
end counter;

architecture behave of counter is
signal count : std_logic_vector (width-1 downto 0);
begin
process(clk, rst)
begin
    if rst = '1' then
        count <= (others => '0');
    elsif (clk'event and clk = '1') then
        if load = '1' then
            count <= data;
        elsif en = '1' then
            count <= count + '1';
        end if;
    end if;
end process;
q <= count;
end behave;

```

## Arithmetic Operators

Synthesis tools generally are able to infer arithmetic operators for the target technology. The following examples infer addition, subtraction, division and multiplication operators.

### *VHDL*

```
library IEEE;
use IEEE.std_logic_1164.all;
use IEEE.std_logic_arith.all;
use IEEE.std_logic_unsigned.all;

entity arithmetic is
port (A, B: in std_logic_vector(3 downto 0);
      Q1: out std_logic_vector(4 downto 0);
      Q2, Q3: out std_logic_vector(3 downto 0);
      Q4: out std_logic_vector(7 downto 0));
end arithmetic;

architecture behav of arithmetic is
begin
process (A, B)
begin
  Q1 <= ('0' & A) + ('0' & B); --addition
  Q2 <= A - B; --subtraction
  Q3 <= A / B; --division
  Q4 <= A * B; --multiplication
end process;
end behav;
```

If the multiply and divide operands are powers of 2, replace them with shift registers. Shift registers provide speed optimized implementations with large savings in area. For example:

```
Q <= C/16 + C*4;
```

can be represented as:

```
Q <= shr (C, "100") + shl (C, "10");
```

or

```
VHDL Q <= "0000" & C (8 downto 4) + C (6 downto 0) & "00";
```

The functions “shr” and “shl” are available in the IEEE.std\_logic\_arith.all library.

### *Verilog*

```
module arithmetic (A, B, Q1, Q2, Q3, Q4);
```

```

    input [3:0] A, B;
    output [4:0] Q1;
    output [3:0] Q2, Q3;
    output [7:0] Q4;
    reg [4:0] Q1;
    reg [3:0] Q2, Q3;
    reg [7:0] Q4;
always @ (A or B)
begin
    Q1 = A + B; //addition
    Q2 = A - B; //subtraction
    Q3 = A / 2; //division
    Q4 = A * B; //multiplication
end
endmodule

```

If the multiply and divide operands are powers of 2, replace them with shift registers. Shift registers provide speed optimized implementations with large savings in area. For example:

$$Q = C/16 + C*4;$$

can be represented as:

$$Q = \{4b'0000\ C[8:4]\} + \{C[6:0]\ 2b'00\};$$

## Relational Operators

Relational operators compare two operands and indicate whether the comparison is true or false. The following examples infer greater than, less than, greater than equal to, and less than equal to comparators. Synthesis tools generally optimize relational operators for the target technology.

### VHDL

```

library IEEE;
use IEEE.std_logic_1164.all;
use IEEE.std_logic_arith.all;

entity relational is
port (A, B : in std_logic_vector(3 downto 0);
      Q1, Q2, Q3, Q4 : out std_logic);
end relational;

architecture behav of relational is
begin
process (A, B)
begin
-- Q1 <= A > B; -- greater than
-- Q2 <= A < B; -- less than

```

```
-- Q3 <= A >= B; -- greater than equal to
if (A <= B) then -- less than equal to
    Q4 <= '1';
else
    Q4 <= '0';
end if;
end process;
end behav;
```

### Verilog

```
module relational (A, B, Q1, Q2, Q3, Q4);
    input [3:0] A, B;
    output Q1, Q2, Q3, Q4;
    reg Q1, Q2, Q3, Q4;

    always @ (A or B)
    begin
        // Q1 = A > B; //greater than
        // Q2 = A < B; //less than
        // Q3 = A >= B; //greater than equal to
        if (A <= B) //less than equal to
            Q4 = 1;
        else
            Q4 = 0;
        end
    endmodule
```

## Equality Operator

The equality and non-equality operators indicate a true or false output based on whether the two operands are equivalent or not. The following examples infer equality operators.

### VHDL

```
library IEEE;
use IEEE.std_logic_1164.all;

entity equality is
port (
    A: in STD_LOGIC_VECTOR (3 downto 0);
    B: in STD_LOGIC_VECTOR (3 downto 0);
    Q1: out STD_LOGIC;
    Q2: out STD_LOGIC
);
end equality;

architecture equality_arch of equality is
begin
    process (A, B)
```

```
begin
  Q1 <= A = B; -- equality
  if (A /= B) then -- inequality
    Q2 <= '1';
  else
    Q2 <= '0';
  end if;
end process;
end equality_arch;
```

### *OR*

```
library IEEE;
use IEEE.std_logic_1164.all;

entity equality is
port (
  A: in STD_LOGIC_VECTOR (3 downto 0);
  B: in STD_LOGIC_VECTOR (3 downto 0);
  Q1: out STD_LOGIC;
  Q2: out STD_LOGIC
);
end equality;

architecture equality_arch of equality is
begin
  Q1 <= '1' when A = B else '0'; -- equality
  Q2 <= '1' when A /= B else '0'; -- inequality
end equality_arch;
```

### *Verilog*

```
module equality (A, B, Q1, Q2);
  input [3:0] A;
  input [3:0] B;
  output Q1;
  output Q2;
  reg Q1, Q2;

  always @ (A or B)
  begin
    Q1 = A == B; //equality
    if (A != B) //inequality
      Q2 = 1;
    else
      Q2 = 0;
    end
  endmodule
```

## Shift Operators

Shift operators shift data left or right by a specified number of bits. The following examples infer left and right shift operators.

### *VHDL*

```
library IEEE;
use IEEE.std_logic_1164.all;
use IEEE.std_logic_arith.all;
use IEEE.std_logic_unsigned.all;

entity shift is
port (data : in std_logic_vector(3 downto 0);
      q1, q2 : out std_logic_vector(3 downto 0));
end shift;

architecture rtl of shift is
begin
  process (data)
  begin
    q1 <= shl (data, "10"); -- logical shift left
    q2 <= shr (data, "10"); --logical shift right
  end process;
end rtl;
```

### *OR*

```
library IEEE;
use IEEE.std_logic_1164.all;

entity shift is
port (data : in std_logic_vector(3 downto 0);
      q1, q2 : out std_logic_vector(3 downto 0));
end shift;

architecture rtl of shift is
begin
  process (data)
  begin
    q1 <= data(1 downto 0) & "10"; -- logical shift left
    q2 <= "10" & data(3 downto 2); --logical shift right
  end process;
end rtl;
```



### Verilog

```
module shift (data, q1, q2);
    input [3:0] data;
    output [3:0] q1, q2;

    parameter B = 2;
    reg [3:0] q1, q2;

    always @ (data)
    begin
        q1 = data << B; // logical shift left
        q2 = data >> B; //logical shift right
    end
endmodule
```

## Finite State Machine

A finite state machine (FSM) is a type of sequential circuit that is designed to sequence through specific patterns of finite states in a predetermined sequential manner. There are two types of FSM, Mealy and Moore. The Moore FSM has outputs that are a function of current state only. The Mealy FSM has outputs that are a function of the current state and primary inputs. An FSM consists of three parts:

1. **Sequential Current State Register:** The register, a set of n-bit flip-flops (state vector flip-flops) clocked by a single clock signal is used to hold the state vector (current state or simply state) of the FSM. A state vector with a length of n-bit has  $2^n$  possible binary patterns, known as state encoding. Often, not all  $2^n$  patterns are needed, so the unused ones should be designed not to occur during normal operation. Alternatively, an FSM with m-state requires at least  $\log_2(m)$  state vector flip-flops.
2. **Combinational Next State Logic:** An FSM can only be in one state at any given time, and each active transition of the clock causes it to change from its current state to the next state, as defined by the next state logic. The next state is a function of the FSM's inputs and its current state.
3. **Combinational Output Logic:** Outputs are normally a function of the current state and possibly the FSM's primary inputs (in the case of a Mealy FSM). Often in a Moore FSM, you may want to derive the outputs from the next state instead of the current state, when the outputs are registered for faster clock-to-out timings.

Moore and Mealy FSM structures are shown in Figure 2-15 and Figure 2-16.

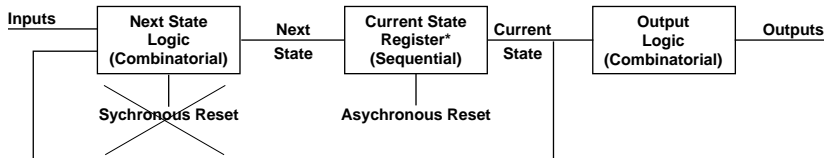

\* State Vector Flip-flops

Figure 2-15. Basic Structure of a Moore FSM

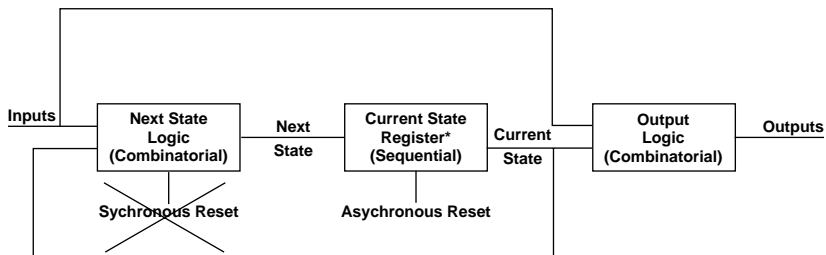

\* State Vector Flip-flops

Figure 2-16. Basic Structure of a Mealy FSM

Use a reset to guarantee fail-safe behavior. This ensures that the FSM is always initialized to a known valid state before the first active clock transition and normal operation begins. In the absence of a reset, there is no way of predicting the initial value of the state register flip-flops during the “power up” operation of an Actel FPGA. It could power up and become permanently stuck in an unencoded state. The reset should be implemented in the sequential current state process of the FSM description.

An asynchronous reset is generally preferred over a synchronous reset because an asynchronous reset does not require decoding unused states, minimizing the next state logic.

Because FPGA technologies are register rich, “one hot” state machine implementations generated by the synthesis tool may generate optimal area and performance results

## Mealy Machine

The following examples represent a Mealy FSM model for the Mealy state diagram shown in Figure 2-17.

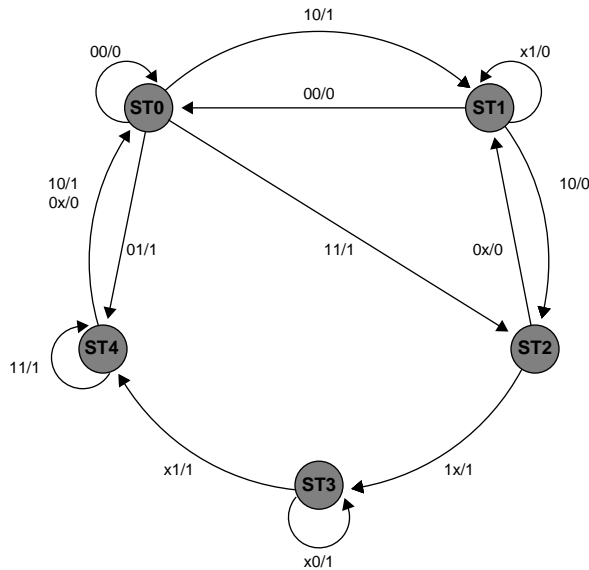

Figure 2-17. Mealy State Diagram

### VHDL

```

-- Example of a 5-state Mealy FSM

library ieee;
use ieee.std_logic_1164.all;

entity mealy is
    port (clock, reset: in std_logic;
          data_out: out std_logic;
          data_in: in std_logic_vector (1 downto 0));
end mealy;

architecture behave of mealy is
    type state_values is (st0, st1, st2, st3, st4);
    signal pres_state, next_state: state_values;
begin
    -- FSM register

```

```
statereg: process (clock, reset)
begin
  if (reset = '0') then
    pres_state <= st0;
  elsif (clock'event and clock = '1') then
    pres_state <= next_state;
  end if;
end process statereg;

-- FSM combinational block
fsm: process (pres_state, data_in)
begin
  case pres_state is
    when st0 =>
      case data_in is
        when "00" => next_state <= st0;
        when "01" => next_state <= st4;
        when "10" => next_state <= st1;
        when "11" => next_state <= st2;
        when others => next_state <= (others <= 'x');
      end case;
    when st1 =>
      case data_in is
        when "00" => next_state <= st0;
        when "10" => next_state <= st2;
        when others => next_state <= st1;
      end case;
    when st2 =>
      case data_in is
        when "00" => next_state <= st1;
        when "01" => next_state <= st1;
        when "10" => next_state <= st3;
        when "11" => next_state <= st3;
        when others => next_state <= (others <= 'x');
      end case;
    when st3 =>
      case data_in is
        when "01" => next_state <= st4;
        when "11" => next_state <= st4;
        when others => next_state <= st3;
      end case;
    when st4 =>
      case data_in is
        when "11" => next_state <= st4;
        when others => next_state <= st0;
      end case;
    when others => next_state <= st0;
  end case;
end process fsm;
```

```

    end case;
end process fsm;

-- Mealy output definition using pres_state w/ data_in
outputs: process (pres_state, data_in)
begin
  case pres_state is
    when st0 =>
      case data_in is
        when "00" => data_out <= '0';
        when others => data_out <= '1';
      end case;
    when st1 => data_out <= '0';
    when st2 =>
      case data_in is
        when "00" => data_out <= '0';
        when "01" => data_out <= '0';
        when others => data_out <= '1';
      end case;
    when st3 => data_out <= '1';
    when st4 =>
      case data_in is
        when "10" => data_out <= '1';
        when "11" => data_out <= '1';
        when others => data_out <= '0';
      end case;
    when others => data_out <= '0';
  end case;
end process outputs;

end behave;

```

### Verilog

```

// Example of a 5-state Mealy FSM

module mealy (data_in, data_out, reset, clock);
output data_out;
input [1:0] data_in;
input reset, clock;

reg data_out;
reg [2:0] pres_state, next_state;

parameter st0=3'd0, st1=3'd1, st2=3'd2, st3=3'd3, st4=3'd4;

// FSM register
always @ (posedge clock or negedge reset)

```

```
begin: statereg
if(!reset)// asynchronous reset
pres_state = st0;
else
pres_state = next_state;
end // statereg

// FSM combinational block
always @(pres_state or data_in)
begin: fsm
case (pres_state)
st0: case(data_in)
2'b00: next_state=st0;
2'b01: next_state=st4;
2'b10: next_state=st1;
2'b11: next_state=st2;
endcase
st1: case(data_in)
2'b00: next_state=st0;
2'b10: next_state=st2;
default: next_state=st1;
endcase
st2: case(data_in)
2'b0x: next_state=st1;
2'b1x: next_state=st3;
endcase
st3: case(data_in)
2'bx1: next_state=st4;
default: next_state=st3;
endcase
st4: case(data_in)
2'b11: next_state=st4;
default: next_state=st0;
endcase
default: next_state=st0;
endcase
end // fsm

// Mealy output definition using pres_state w/ data_in
always @(data_in or pres_state)
begin: outputs
case(pres_state)
st0: case(data_in)
2'b00: data_out=1'b0;
default: data_out=1'b1;
endcase
```

```

        st1:      data_out=1'b0;
        st2:      case(data_in)
        2'b0x:    data_out=1'b0;
        default:  data_out=1'b1;
        endcase
        st3:      data_out=1'b1;
        st4:      case(data_in)
        2'b1x:    data_out=1'b1;
        default:  data_out=1'b0;
        endcase
        default:  data_out=1'b0;
        endcase
    end // outputs

endmodule

```

## Moore Machine

The following examples represent a Moore FSM model for the Mealy state diagram shown in [Figure 2-17 on page 51](#).

### *VHDL*

```

-- Example of a 5-state Moore FSM

library ieee;
use ieee.std_logic_1164.all;

entity moore is
    port (clock, reset: in std_logic;
          data_out: out std_logic;
          data_in: in std_logic_vector (1 downto 0));
end moore;

architecture behave of moore is
    type state_values is (st0, st1, st2, st3, st4);
    signal pres_state, next_state: state_values;
begin
    -- FSM register
    statereg: process (clock, reset)
    begin
        if (reset = '0') then
            pres_state <= st0;
        elsif (clock = '1' and clock'event) then
            pres_state <= next_state;
        end if;
    end process statereg;
end behave;

```

```
-- FSM combinational block
fsm: process (pres_state, data_in)
begin
  case pres_state is
    when st0 =>
      case data_in is
        when "00" => next_state <= st0;
        when "01" => next_state <= st4;
        when "10" => next_state <= st1;
        when "11" => next_state <= st2;
        when others => next_state <= (others <= 'x');

      end case;
    when st1 =>
      case data_in is
        when "00" => next_state <= st0;
        when "10" => next_state <= st2;
        when others => next_state <= st1;

      end case;
    when st2 =>
      case data_in is
        when "00" => next_state <= st1;
        when "01" => next_state <= st1;
        when "10" => next_state <= st3;
        when "11" => next_state <= st3;
        when others => next_state <= (others <= 'x');

      end case;
    when st3 =>
      case data_in is
        when "01" => next_state <= st4;
        when "11" => next_state <= st4;
        when others => next_state <= st3;

      end case;
    when st4 =>
      case data_in is
        when "11" => next_state <= st4;
        when others => next_state <= st0;

      end case;
    when others => next_state <= st0;
  end case;
end process fsm;

-- Moore output definition using pres_state only
outputs: process (pres_state)
begin
  case pres_state is
```



```

        when st0    => data_out <= '1';
        when st1    => data_out <= '0';
        when st2    => data_out <= '1';
        when st3    => data_out <= '0';
        when st4    => data_out <= '1';
        when others => data_out <= '0';
    end case;
end process outputs;

end behave;

```

### *Verilog*

```

// Example of a 5-state Moore FSM

module moore (data_in, data_out, reset, clock);
    output data_out;
    input [1:0] data_in;
    input reset, clock;

    reg data_out;
    reg [2:0] pres_state, next_state;

    parameter st0=3'd0, st1=3'd1, st2=3'd2, st3=3'd3, st4=3'd4;

//FSM register
always @(posedge clock or negedge reset)
    begin: statereg
        if(!reset)
            pres_state = st0;
        else
            pres_state = next_state;
        end // statereg

// FSM combinational block
always @(pres_state or data_in)
    begin: fsm
        case (pres_state)
            st0:    case(data_in)
                2'b00:    next_state=st0;
                2'b01:    next_state=st4;
                2'b10:    next_state=st1;
                2'b11:    next_state=st2;
            endcase
            st1:    case(data_in)
                2'b00:    next_state=st0;
                2'b10:    next_state=st2;

```

```
        default:      next_state=st1;
    endcase
st2:    case(data_in)
        2'b0x:      next_state=st1;
        2'b1x:      next_state=st3;
    endcase
st3:    case(data_in)
        2'bx1:      next_state=st4;
        default:    next_state=st3;
    endcase
st4:    case(data_in)
        2'b11:      next_state=st4;
        default:    next_state=st0;
    endcase
default: default:      next_state=st0;
endcase
end // fsm

// Moore output definition using pres_state only
always @(pres_state)
begin: outputs
    case(pres_state)
        st0:      data_out=1'b1;
        st1:      data_out=1'b0;
        st2:      data_out=1'b1;
        st3:      data_out=1'b0;
        st4:      data_out=1'b1;
        default:  data_out=1'b0;
    endcase
end // outputs

endmodule // Moore
```

## Input-Output Buffers

You can infer or instantiate a I/O buffers in your design. The following examples represent both techniques. Regardless of which method you use, all I/O buffers should be declared at the top level of the design.

## Tri-State Buffer

A tri-state buffer is an output buffer with high-impedance capability. The following examples show how to infer and instantiate a tri-state buffer.

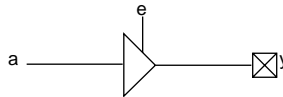

Figure 2-18. Tri-State Buffer

### Inference

#### VHDL

```

library IEEE;
use IEEE.std_logic_1164.all;

entity tristate is
port (e, a : in std_logic;
      y : out std_logic);
end tristate;

architecture tri of tristate is
begin
  process (e, a)
  begin
    if e = '1' then
      y <= a;
    else
      y <= 'Z';
    end if;
  end process;
end tri;

```

#### OR

```

library IEEE;
use IEEE.std_logic_1164.all;

entity tristate is
port (e, a : in std_logic;
      y : out std_logic);
end tristate;

architecture tri of tristate is
begin
  Y <= a when (e = '1') else 'Z';
end tri;

```

```
end tri;
```

### *Verilog*

```
module TRISTATE (e, a, y);
  input a, e;
  output y;
  reg y;
  always @ (e or a) begin
    if (e)
      y = a;
    else
      y = 1'bz;
    end
endmodule
```

### *OR*

```
module TRISTATE (e, a, y);
  input a, e;
  output y;

  assign y = e ? a : 1'bZ;

endmodule
```

## Instantiation

### *VHDL*

```
library IEEE;
use IEEE.std_logic_1164.all;

entity tristate is
  port (e, a : in std_logic;
        y : out std_logic);
end tristate;

architecture tri of tristate is

  component TRIBUFF
    port (D, E: in std_logic;
          PAD: out std_logic);
  end component;

begin
  U1: TRIBUFF port map (D => a,
                       E => e,
```

```

        PAD => y);
end tri;

```

### Verilog

```

module TRISTATE (e, a, y);
input a, e;
output y;

TRIBUFF U1 (.D(a), .E(e), .PAD(y));

endmodule

```

## Bi-Directional Buffer

A bi-directional buffer can be an input or output buffer with high impedance capability. The following examples show how to infer and instantiate a bi-directional buffer.

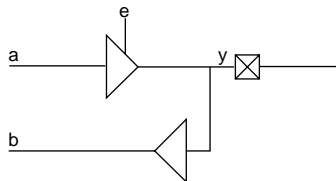

Figure 2-19. Bi-Directional Buffer

## Inference

### VHDL

```

library IEEE;
use IEEE.std_logic_1164.all;

entity bidir is
port (y : inout std_logic;
      e, a: in std_logic;
      b : out std_logic);
end bidir;

architecture bi of bidir is
begin
process (e, a)
begin
case e is
when '1' => y <= a;
when '0' => y <= 'Z';
end case;
end process;
end architecture bi;

```

```
        when others => y <= 'X';
    end case;
end process;
b <= y;
end bi;
```

### *Verilog*

```
module bidir (e, y, a, b);
    input a, e;
    inout y;
    output b;
    reg y_int;
    wire y, b;

    always @ (a or e)
    begin
        if (e == 1'b1)
            y_int <= a;
        else
            y_int <= 1'bz;
        end
        assign y = y_int;
        assign b = y;
    endmodule
```

## Instantiation

### *VHDL*

```
library IEEE;
use IEEE.std_logic_1164.all;

entity bidir is
    port (y : inout std_logic;
          e, a: in std_logic;
          b : out std_logic);
end bidir;

architecture bi of bidir is

    component BIBUF
        port (D, E: in std_logic;
              Y : out std_logic;
              PAD: inout std_logic);
    end component;
```

```

begin
U1: BIBUF port map (D => a,
                    E => e,
                    Y => b,
                    PAD => y);
end bi;
    
```

### *Verilog*

```

module bidir (e, y, a, b);
    input a, e;
    inout y;
    output b;

    BIBUF U1 ( .PAD(y), .D(a), .E(e), .Y(b) );
endmodule
    
```

## Generics and Parameters

Generics and parameters are used to define the size of a component. This allows the design of parameterized components for the size and feature sets that may be defined by values of the instantiation parameters. The following examples show how to use generics and parameters when describing a parameterized adder. Furthermore, this adder is instantiated for varying widths.

### *VHDL*

```

library IEEE;
use IEEE.std_logic_1164.all;
use IEEE.std_logic_arith.all;
use IEEE.std_logic_unsigned.all;

entity adder is
    generic (WIDTH : integer := 8);
    port (A, B: in UNSIGNED(WIDTH-1 downto 0);
          CIN: in std_logic;
          COUT: out std_logic;
          Y: out UNSIGNED(WIDTH-1 downto 0));
end adder;

architecture rtl of adder is
begin
    process (A,B,CIN)
        variable TEMP_A,TEMP_B,TEMP_Y:UNSIGNED(A'length downto 0);
    begin
        TEMP_A := '0' & A;
        TEMP_B := '0' & B;
    end process;
end architecture;
    
```

```
        TEMP_Y := TEMP_A + TEMP_B + CIN;
        Y <= TEMP_Y (A'length-1 downto 0);
        COUT <= TEMP_Y (A'length);
    end process;
end rtl;
```

“Width” indicates the width of the adder. The instantiation for this parameterized adder for a bit width of 16 is:

```
U1: adder generic map(16) port map (A_A, B_A, CIN_A, COUT_A,
    Y_A);
```

### *Verilog*

```
module adder (cout, sum, a, b, cin);
    parameter Size = 8;
    output cout;
    output [Size-1:0] sum;
    input cin;
    input [Size-1:0] a, b;

    assign {cout, sum} = a + b + cin;

endmodule
```

“Size” indicates the width of the adder. The instantiation for this parameterized adder for a bit width of 16 is:

```
adder #(16) adder16(cout_A, sun_A, a_A, b_A, cin_A)
```



## Performance Driven Coding

Unlike ASICs, FPGAs are module based arrays. Each logic level used on a path can add delay. As a result, meeting timing constraints on a critical path with too many logic levels becomes difficult. Using an efficient coding style is very important because it dictates the synthesis logic implementation. This chapter describes synthesis implementations, techniques, and efficient design practices that can be used to reduce logic levels on a critical path.

### Reducing Logic Levels on Critical Paths

Each logic level on the critical path in an FPGA can add significant delay. To ensure that timing constraints can be met, logic level usage must be considered when describing the behavior of a design. The following examples illustrate how to reduce logic levels on critical paths.

#### Example 1

In the following VHDL example, the signal “critical” goes through three logic levels.

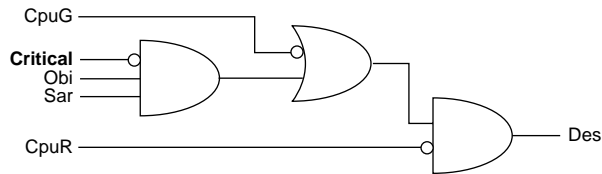

```

if ((( Critical='0' and Obi='1' and Sar='1')
or CpuG='0') and CpuR='0') then
  Des <= Adr;
elsif (((Critical='0' and Obi='1' and Sar='1')
or CpuG='0') and CpuR='1') then
  Des <= Bdr;
elsif (Sar='0' and .....

```

The signal “critical” is a late arriving signal. To reduce the logic level usage on “critical”, imply priority by using an if-then-else statement. As a result, the signal “critical” goes through one logic level, as shown below.

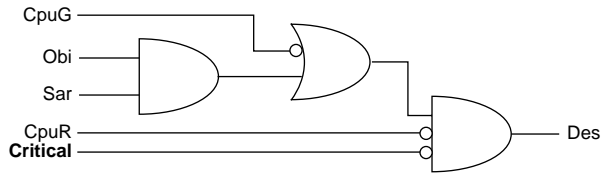

```

if (Critical='0') then
  if (((Obi='1' and Sar='1')
    or CpuG='0') and CpuR='0') then
    Des <= Adr;
  elsif (((Obi='1' and Sar='1')
    or CpuG='0' and CpuR='1') then
    Des <= Bdr;
  end if;
end if;

```

## Example 2

In the following example, the signal “critical” goes through two logic levels.

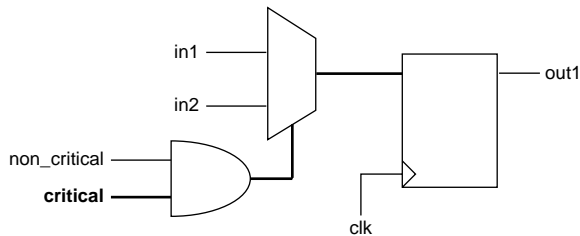

```

if (clk'event and clk = '1') then
  if (non_critical and critical) then
    out1 <= in1 ;
  else
    out1 <= in2 ;
  end if;
end if;

```

To reduce the logic level usage on “critical”, multiplex inputs “in1” and “in2” based on “non\_critical”, and call this output “out\_temp”. Then multiplex “out\_temp” and “in2” based on “critical”. As a result, the signal “critical” goes through one logic level, as shown below.

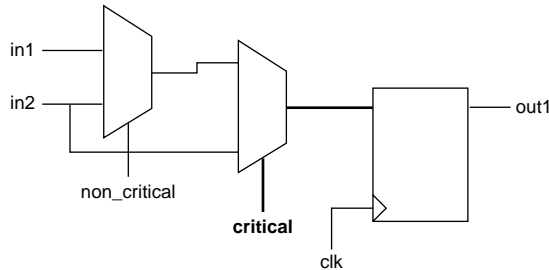

```

signal out_temp : std_logic
if (non_critical)
    out_temp <= in1;
else out_temp <= in2;
if (clk'event and clk = '1') then
    if (critical) then
        out1 <= out_temp;
    else out1 <= in2;
    end if;
end if;
end if;

```

## Resource Sharing

Resource sharing can reduce the number of logic modules needed to implement HDL operations. Without it, each HDL description is built into a separate circuit. The following VHDL examples illustrate how to use resource sharing to reduce logic module utilization.

### Example 1

This example implements four adders.

```
if (...(siz == 1)...)
    count = count + 1;
else if (...(siz ==2)...)
    count = count + 2;
else if (...(siz == 3)...)
    count = count + 3;
else if (...(siz == 0)...)
    count = count + 4;
```

By adding the following code, two adders can be eliminated:

```
if (...(siz == 0)...)
    count = count + 4;
else if (...)
    count = count + siz
```

### Example 2

This example uses poor resource sharing to implement adders.

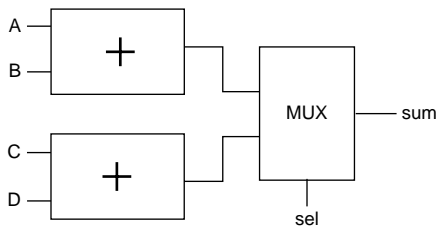

```
if (select)
    sum <= A + B;
else
    sum <= C + D;
```

Adders use valuable resources. To reduce resource usage, rewrite the code to infer two multiplexors and one adder, as shown below.

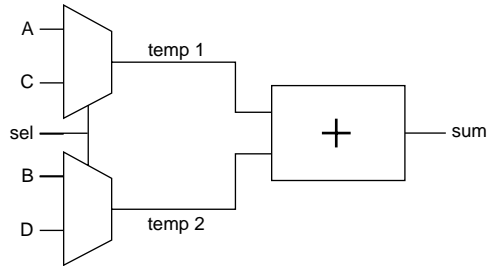

```
if (sel)
    temp1 <= A;
    temp2 <= B;
else
    temp1 <= C;
    temp2 <= D;
sum <= temp1 + temp2;
```

**Note:** This example assumes the select line is not a late arriving signal.

## Operators Inside Loops

Operators are resource intensive compared to multiplexors. If there is an operator inside a loop, the synthesis tool has to evaluate all conditions. In the following VHDL example, the synthesis tool builds four adders and one multiplexor. This implementation is only advisable if the select line “req” is a late arriving signal.

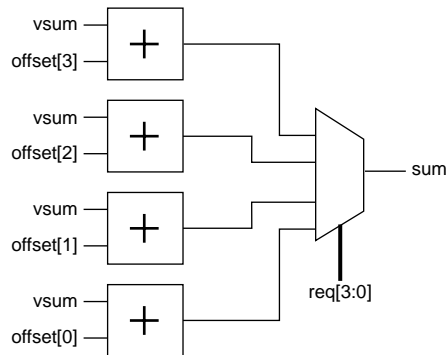

```
vsum := sum;  
for i in 0 to 3 loop  
  if (req(i)='1') then  
    vsum <= vsum + offset(i);  
  end if;  
end loop;
```

If the select line “req” is not critical, the operator should be moved outside the loop so the synthesis tool can multiplex the data before performing the adder operation. The area efficient design is implemented in a larger multiplexor and a single adder, as shown below.

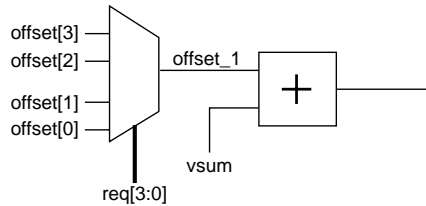

```

vsum := sum;
for i in 0 to 3 loop
    if (req(i)='1') then
        offset_1 <= offset(i);
    end if;
end loop;
vsum <= vsum + offset_1;

```

## Coding for Combinability

Combinatorial modules can be merged into sequential modules in the antifuse architecture. This results in a significant reduction in delay on the critical path as well as area reduction. However, cells are only merged if the combinatorial module driving a basic flip-flop has a load of 1. In the following VHDL example, the AND gate driving the flip-flop has a load of 2. As a result, the AND gate cannot be merged into the sequential module.

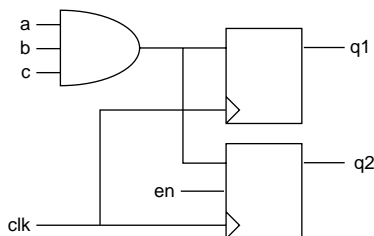

```
one :process (clk, a, b, c, en) begin
    if (clk'event and clk = '1') then
        if (en = '1') then
            q2 <= a and b and c;
        end if;
        q1 <= a and b and c;
    end if;
end process one;
```

To enable merging, the AND gate has to be duplicated so that it has a load of 1. To duplicate the AND gate, create two independent processes, as shown below. Once merged, one logic level has been removed from the critical path.

**Note:** Some synthesis tools automatically duplicate logic on the critical path. Other synthesis tools detect the function “a & b & c” in the two processes and share the function on a single gate. If the function is shared, the logic is not duplicated and you should consider instantiation.

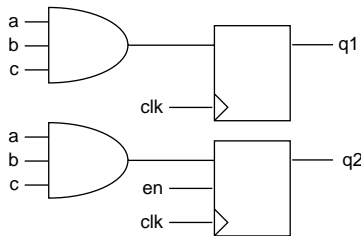

```
part_one: process (clk, a, b, c, en) begin
    if (clk'event and clk = '1') then
        if (en = '1') then
            q2 <= a and b and c;
        end if;
    end if;
end process part_one;
part_two: process (clk, a, b, c) begin
    if (clk'event and clk = '1') then
        q1 <= a and b and c;
    end if;
end process part_two;
```

## Register Duplication

The delay on a net rises as the number of loads increase in the antifuse architecture. This is acceptable for networks such as reset, but not others such as tri-state enable, etc. It is important to



keep the fanout of a network below 16. In the following VHDL example, the signal “Tri\_en” has a fanout of 24.

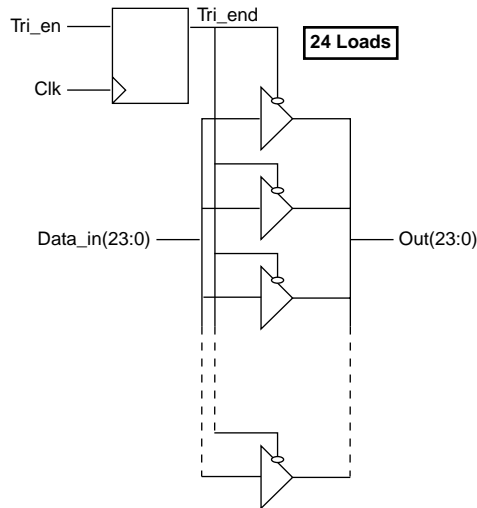

```

architecture load of four_load is
    signal Tri_en std_logic;
begin
    loadpro: process (Clk)
    begin
        if (clk'event and clk = '1') then
            Tri_end <= Tri_en;
        end if;
    end process loadpro;

    endpro : process (Tri_end, Data_in)
    begin
        if (Tri_end = '1') then
            out <= Data_in;
        else
            out <= (others => 'Z');
        end if;
    end process endpro;
end load;
    
```

To decrease the fanout by half, registers are duplicated on the signal “Tri\_en” so the load is split in half, as shown in the following example.

**Note:** Some synthesis tools duplicate registers to resolve timing and fanout violations and do not require this coding technique.

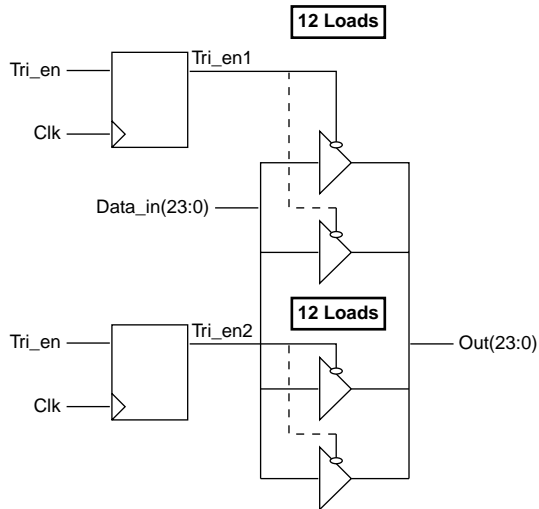

```

architecture loada of two_load is
    signal Tri_en1, Tri_en2 : std_logic;
begin
loadpro: process (Clk)
    begin
        if (clk'event and clk = '1') then
            Tri_en1 <= Tri_en;
            Tri_en2 <= Tri_en;
        end if;
    end process loadpro;

process (Tri_en1, Data_in)
    begin
        if (Tri_en1 = '1') then
            out(23:12) <= Data_in(23:12);
        else
            out(23:12) <= (others => 'Z');
        end if;
    end process;

process (Tri_en2, Data_in)
    begin
        if (Tri_en2 = '1') then
            out(11:0) <= Data_in(11:0);
        else

```

```
        out(11:0) <= (others => 'Z');  
    end if;  
end process;
```

## Partitioning a Design

Most synthesis tools work best when optimizing medium sized blocks, approximately two to five thousand gates at a time. To reduce synthesis time, you should partition designs so that module block sizes do not exceed the recommendations of the synthesis tool vendor. When partitioning a design into various blocks, it is good design practice to have registers at hierarchical boundaries. This eliminates the need for time budgeting on the inputs and outputs. The following example shows how to modify your HDL code so that registers are placed at hierarchical boundaries.

### Registers Embedded Within a Module

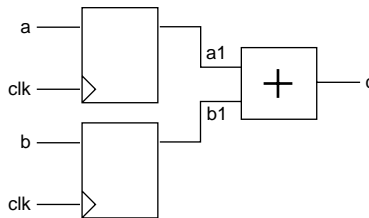

```
process (clk, a, b) begin
    if (clk'event and clk = '1') then
        a1 <= a;
        b1 <= b;
    end if;
end process;

process (a1, b1)
begin c <= a1 + b1;
end process;
```

## Registers Pushed Out at the Hierarchical Boundary

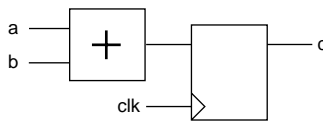

```
process (clk, a, b) begin
    if (clk'event and clk = '1') then
        c <= a + b;
    end if;
end process;
```

---

# Technology Specific Coding Techniques

In addition to technology independent and performance driven coding, there are coding techniques that you can use to take advantage of the Actel architecture to improve speed and area utilization of your design. Additionally, most synthesis tools can implement random logic, control logic and certain datapath macros. However, they may not generate technology optimal implementations for datapath elements that cannot be inferred using operators, such as counters, RAM, FIFO, etc. This chapter describes coding techniques to take advantage of technology specific features and how to instantiate technology specific macros generated by the ACTgen Macro Builder tool for optimal area and performance.

## Multiplexors

Using case statements with the multiplexor based Actel architecture provides area and speed efficient solutions and is more efficient than inference of priority encoders using if-then-else statements. Actel recommends that you use case statements instead of long, nested if-then-else statements to force mapping to multiplexors in the Actel architecture. Refer to [“Multiplexors Using Case” on page 34](#) for examples of multiplexor coding.

VHDL synthesis tools automatically assume parallel operation without priority in case statements. However, some Verilog tools assume priority, and you may need to add a directive to your case statement to ensure that no priority is assumed. Refer to the documentation provided with your synthesis tool for information about creating case statements without priority.

## Internal Tri-State to Multiplexor Mapping

All internal tri-states must be mapped to multiplexors. The antifuse technology only supports tri-states as in/out ports, but not internal tri-states. The following examples show an internal tri-state followed by a multiplexor that the internal tri-state should change to.

**Note:** Some synthesis tools automatically map internal tri-states to multiplexors.

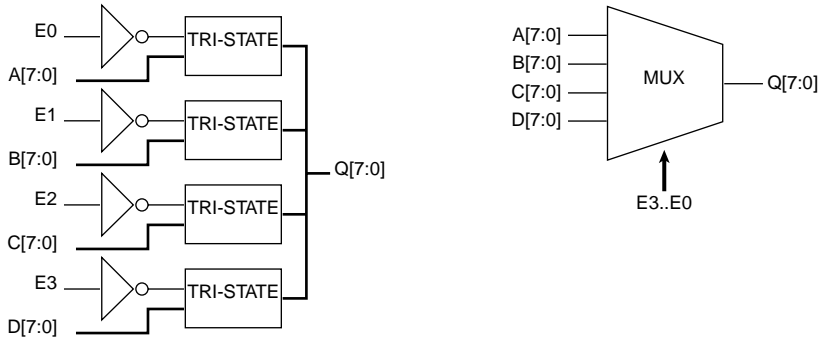

### VHDL Tri-State

```

library IEEE;
use IEEE.std_logic_1164.all;
entity tribus is
  port (A, B, C, D : in std_logic_vector(7 downto 0));
        E0, E1, E2, E3 : in std_logic;
        Q : out std_logic_vector(7 downto 0));
end tribus;

architecture rtl of tribus is
begin
  Q <= A when(E0 = '1') else "ZZZZZZZZ";
  Q <= B when(E1 = '1') else "ZZZZZZZZ";
  Q <= C when(E2 = '1') else "ZZZZZZZZ";
  Q <= D when(E3 = '1') else "ZZZZZZZZ";
end rtl;

```

### VHDL Multiplexor

```

library IEEE;
use IEEE.std_logic_1164.all;
entity muxbus is
  port (A, B, C, D : in std_logic_vector(7 downto 0));
        E0, E1, E2, E3 : in std_logic;
        Q : out std_logic_vector(7 downto 0));
end muxbus;

architecture rtl of muxbus is
  signal E_int : std_logic_vector(1 downto 0);
begin
  process (E0, E1, E2, E3)

```

```

variable E : std_logic_vector(3 downto 0);
begin
  E := E0 & E1 & E2 & E3;
  case E is
    when "0001" => E_int <= "00";
    when "0010" => E_int <= "01";
    when "0100" => E_int <= "10";
    when "1000" => E_int <= "11";
    when others => E_int <= "--";
  end case;
end process;

process (E_int, A, B, C, D)
begin
  case E_int is
    when "00" => Q <= D;
    when "01" => Q <= C;
    when "10" => Q <= B;
    when "11" => Q <= A;
    when others => Q <= (others => '-');
  end case;
end process;
end rtl;

```

### *Verilog Tri-State*

```

module tribus (A, B, C, D, E0, E1, E2, E3, Q);

  input [7:0]A, B, C, D;
  output [7:0]Q;
  input E0, E1, E2, E3;

  assign Q[7:0] = E0 ? A[7:0] : 8'bzzzzzzzz;
  assign Q[7:0] = E1 ? B[7:0] : 8'bzzzzzzzz;
  assign Q[7:0] = E2 ? C[7:0] : 8'bzzzzzzzz;
  assign Q[7:0] = E3 ? D[7:0] : 8'bzzzzzzzz;

endmodule

```

### *Verilog Multiplexor*

```

module muxbus (A, B, C, D, E0, E1, E2, E3, Q);
  input [7:0]A, B, C, D;
  output [7:0]Q;
  input E0, E1, E2, E3;
  wire [3:0] select4;
  reg [1:0] select2;
  reg [7:0]Q;

  assign select4 = {E0, E1, E2, E3};

  always @ (select4)

```

```
begin
  case(select4)
    4'b0001 : select2 = 2'b00;
    4'b0010 : select2 = 2'b01;
    4'b0100 : select2 = 2'b10;
    4'b1000 : select2 = 2'b11;
    default : select2 = 2'bxx;
  endcase
end

always @ (select2 or A or B or C or D)
begin
  case(select2)
    2'b00 : Q = D;
    2'b01 : Q = C;
    2'b10 : Q = B;
    2'b11 : Q = A;
  endcase
end

endmodule
```

## Registers

The XL, DX, MX, SX and ACT 3 families have dedicated asynchronous reset registers in the sequential modules (SMOD). In each SMOD is a 4:1 multiplexor with some gating logic on the select lines. Implementing a simple register or an asynchronous reset register allows the gating logic in front of the register to be pulled into the SMOD, reducing the path delay by one level. This is called full combinability. Full combinability offers improved speed, increasing a 50MHz operation to 75MHz in some designs. The following examples show how to use registers for combinability and discuss any speed or area penalty associated with using the register.



## Synchronous Clear or Preset

The synchronous clear or preset register only uses part of the SMOD multiplexor, allowing for some combinability. The following example shows how to share a synchronous register with a 2:1 multiplexor.

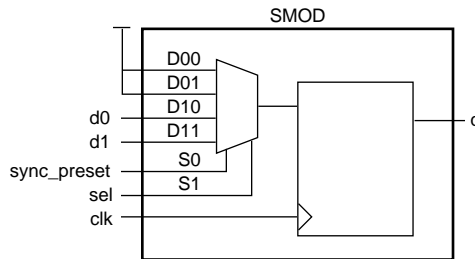

Figure 4-20. Single Module Implementation of a Synchronous Clear or Preset Register

### VHDL

```
-- register with active low sync preset shared with a 2-to-1 mux.

library ieee;
use ieee.std_logic_1164.all;
entity dfm_sync_preset is
PORT (d0, d1: in std_logic;
      clk, preset, sel: in std_logic;
      q: out std_logic;
end dfm_sync_preset;

architecture behav of dfm_sync_preset is
signal tmp_sel: std_logic_vector(1 downto 0);
signal q_tmp: std_logic;
begin
process (clk) begin
tmp_sel <= preset & sel;
if (clk'event and clk = '1') then
case tmp_sel is
when "00" => q_tmp <= '1';
when "01" => q_tmp <= '1';
when "10" => q_tmp <= d0;
when "11" => q_tmp <= d1;
when others => q_tmp <= '1';
end case;
end if;
end process;
q <= q_tmp;
```

```
end behav;
```

### Verilog

```
/* register with active-low synchronous preset shared with
2-to-1 mux */

module dfm_sync_preset (d0, d1, clk, sync_preset, sel, q);
input d0, d1;
input sel;
input clk, sync_preset;
output q;
reg q;
always @ (posedge clk)
begin
    case ({sync_preset, sel})
        2'b00: q = 1'b1;
        2'b01: q = 1'b1;
        2'b10: q = d0;
        2'b11: q = d1;
    endcase
end
endmodule
```

## Clock Enabled

The clock enabled register uses a 2:1 multiplexor with output feedback, which uses some of the SMOD multiplexor. The following example shows how to share a clock enabled register with the input logic.

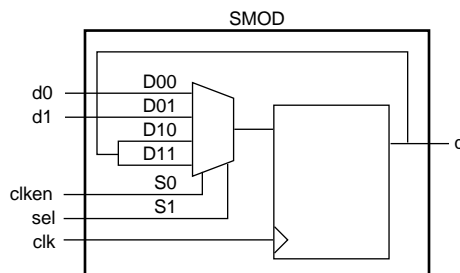

Figure 4-21. Single Module Implementation of a Clock Enabled Register

### VHDL

```
-- register with active low async reset, shared with a 2-to-1
```

```
-- mux, and an active high clock enable.

library ieee;
use ieee.std_logic_1164.all;
entity dfm_clken is
PORT (d0, d1: in std_logic;
      clk, reset, clken, sel: in std_logic;
      q: out std_logic;
end dfm_clken;

architecture behav of dfm_clken is
signal tmp_sel: std_logic_vector(1 downto 0);
signal q_tmp: std_logic;
begin
process (clk, reset) begin
    tmp_sel <= clken & sel;
    if (reset = '0') then
        q_tmp <= '0';
    elsif (clk'event and clk = '1') then
        case tmp_sel is
            when "00" => q_tmp <= d0;
            when "01" => q_tmp <= d1;
            when "10" => q_tmp <= q_tmp;
            when "11" => q_tmp <= q_tmp;
            when others => q_tmp <= q_tmp;
        end case;
    end if;
end process;
q <= q_tmp;
end behav;
```

### *Verilog*

```
/* register with asynchronous reset, clock enable,
shared with a 2-to-1 mux */
```

```

module dfm_clken (d0, d1, clk, reset, clken, sel, q);
input d0, d1;
input sel;
input clk, reset, clken;
output q;
reg q;
always @ (posedge clk or negedge reset)
begin
  if (!reset)
    q = 1'b0;
  else
    case ({clken, sel})
      2'b00: q = d0;
      2'b01: q = d1;
      2'b10: q = q;
      2'b11: q = q;
    endcase
end
endmodule

```

## Asynchronous Preset

Some synthesis tools automatically translate an asynchronous preset register into an asynchronous reset register without performance penalties. The bubbled logic can then be pushed into the surrounding logic without any delay penalty. There are various types of preset registers in the Actel libraries. Some of the registers use two combinatorial modules (CMOD) and most use an inverter, which consumes part of the SMOD multiplexor. If your synthesis tool does not automatically translate an asynchronous preset register into a functionally equivalent asynchronous preset register using an asynchronous reset register, use the following examples to design an asynchronous reset register.

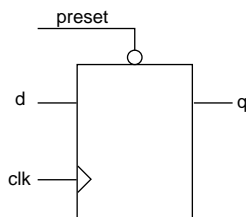

Figure 4-22. Asynchronous Reset

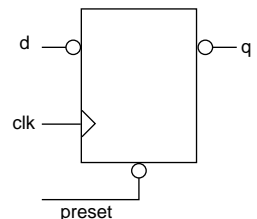

Figure 4-23. Equivalent Asynchronous Reset

### *Verilog Asynchronous Preset*

```
// Active-low async preset flip-flop

module dfp (q, d, clk, preset);
input d, clk, preset;
output q;
reg q;

    always @(posedge clk or negedge preset)
        if (!preset)
            q = 1'b1;
        else
            q = d;
endmodule
```

### *Verilog Equivalent Asynchronous Preset*

```
/* Equivalent active-low async preset flip-flop, using an async reset flop
with bubbled d and q */

module dfp_r (q, d, clk, preset);
input d, clk, preset;
output q;
wire d_inv, reset;
reg q_inv;

assign d_inv = !d;
assign q = !q_inv;
assign reset = preset;
always @(posedge clk or negedge reset)
    if (!reset)
        q_inv = 1'b0;
    else
        q_inv = d_inv;
endmodule
```

### *VHDL Asynchronous Preset*

```
-- register with active low async preset.

library ieee;
use ieee.std_logic_1164.all;
entity dfp is
    port (d, clk, preset : in std_logic;
          q : out std_logic);
end dfp;

architecture behav of dfp is
begin
```

```
process (clk, preset) begin
    if (preset = '0') then
        q <= '1';
    elsif (clk'event and clk = '1') then
        q <= d;
    end if;
end process;
end behav;
```

### *VHDL Equivalent Asynchronous Preset*

```
-- register with active low async preset.

library ieee;
use ieee.std_logic_1164.all;
entity dfp_r is
    port (d, clk, preset : in std_logic;
          q : out std_logic);
end dfp_r;

architecture behav of dfp_r is
    signal reset, d_tmp, q_tmp : std_logic;
begin
    reset <= preset;
    d_tmp <= NOT d;
    process (clk, reset) begin
        if (reset = '0') then
            q_tmp <= '0';
        elsif (clk'event and clk = '1') then
            q_tmp <= d_tmp;
        end if;
    end process;
    q <= NOT q_tmp;
end behav;
```

## Asynchronous Preset and Clear

This is the most problematic register for the ACT 2, XL, DX, MX, SX and ACT 3 architectures. You can only use one cell (the DFPC cell) to design an asynchronous preset and clear register. The DFPC uses two CMODs to form a master latch and a slave latch that together form one register. This uses two CMODs per register and offers no logic combinability with the SMOD. The DFPC requires more setup time and no combinability. The net timing loss can often be as high as 10ns. Actel recommends that you do not use any asynchronous preset and clear registers on critical paths. Use a synchronous preset with asynchronous clear or a synchronous clear register instead.

You can use an asynchronous preset and clear register if it does not affect a critical path or cause high utilization in the design.

## Registered I/Os

The ACT 3 technology has registers in the I/O ring, with both reset and preset, which allow for fast input setup and clock-to-out delays. Because most synthesis tools do not infer these special resources, the following example shows how to instantiate a registered I/O cell, BREPTH, in your design.

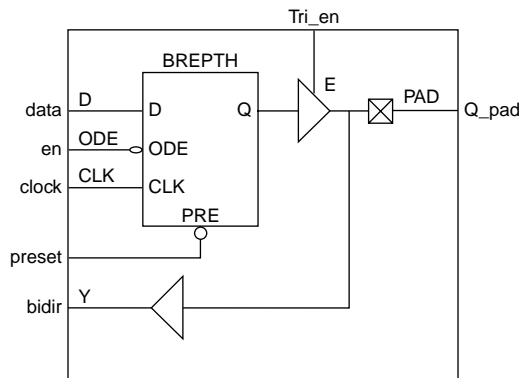

Figure 4-24. Registered I/O Cell

### VHDL

```

library IEEE;
use IEEE.std_logic_1164.all;

entity regio is
    port (data, en, Tri_en, clock, preset : in std_logic;
          bidir : inout std_logic;
          q_pad : out std_logic);
end regio;

architecture rtl of regio is

    -- Component Declaration
    component BREPTH
        port (D, ODE, E, IOPCL, CLK : in std_logic;
             Y : out std_logic;

```

```
        PAD : inout std_logic);
end component;

begin
-- Concurrent Statement
U0 : BREPTH port map ( D => data,
                    ODE => en,
                    E => Tri_en,
                    IOPCL => preset,
                    CLK => clock,
                    Y => q_pad,
                    PAD => bidir);

end rtl;
```

### *Verilog*

```
module regio (data, Q_pad, clock, preset, Tri_en, en, bidir);

    input  data, clock, preset, Tri_en, en;
    output Q_pad;
    inout  bidir;

    BREPTH U1 (.PAD(Q_pad), .D(data), .CLK(clock), .IOPCL(preset),
              .E(Tri_en), .ODE(en), .Y(bidir));

endmodule
```

**Note:** As a good design practice, instantiate all input/output cells at the top level of your design.

## CLKINT/CLKBUF for Reset and/or High Fanout Networks

Many designs have internally generated clocks, high fanout control signals, or internally generated reset signals. These signals need a large internal driver, CLKINT, to meet both area and performance goals for the circuit. If the high fanout signals come directly into the design through an I/O, a CLKBUF driver is used. Most synthesis tools do not automatically use these drivers. Instead, the synthesis tool builds a buffer tree that consumes one module per driver. On a high fanout net this can affect both the area and timing for that signal. If the global drivers for a given array are still available, you should instantiate the CLKINT or CLKBUF driver into the design. The following example shows how to instantiate these drivers.



## CLKINT

The following examples instantiate the CLKINT driver.

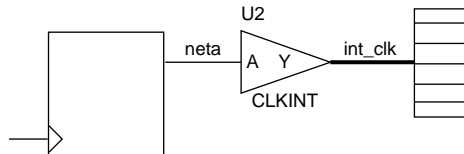

### VHDL

```

library IEEE;
use IEEE.std_logic_1164.all;

entity design is
  port (..... : in std_logic;
        ..... : out std_logic);
end design;

  architecture rtl of design is
    signal neta, int_clk : std_logic;
-- Component Declaration
  component CLKINT
    port (A : in std_logic;
          Y : out std_logic);
  end component;

begin
-- Concurrent Statement
U2 : CLKINT port map ( A => neta,
                      Y => int_clk);
end rtl;

```

### Verilog

```

module design (.....);

  input .....;
  output .....;
  CLKINT U2 (.Y(int_clk), .A(neta));
  .....
  .....
endmodule

```

## CLKBUF

The following examples instantiate a CLKBUF driver.

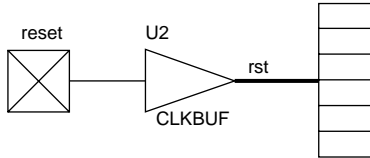

### VHDL

```

library IEEE;
use IEEE.std_logic_1164.all;

entity design is
port (PAD : in std_logic;
       Y : out std_logic);
end component;

begin
    -- Concurrent Statement
    U2 : CLKBUF port map (PAD => reset, Y => rst_rst);
end rtl;

```

### Verilog

```

module design (.....);

    input .....;
    output .....;
    CLKBUF U2 (.Y(rst), .PAD(reset));
    .....
    .....
endmodule

```

## QCLKINT/QCLKBUF for Medium Fanout Networks

The 32100DX, 32200DX, 32300DX, and 42MX36 have four quadrant clocks that can be used to drive internally generated high fanout nets (QCLKINT) or high fanout nets generated from I/O ports (QCLKBUF). The methodology and instantiation are similar to the CLKINT/CLKBUF drivers. However, the QCLK drivers can only drive within a quadrant. Although the placement of the cells into a quadrant is automated by the Designer place-and-route software, you must limit the number of fanouts and prevent the use of multiple QCLK signals to drive the same cell or gate.

You can double your fanout limit and drive half the chip by combining two drivers into one to drive 2 quadrants. However, each time you combine drivers, you reduce the number of available QCLKs by one. The Designer place-and-route software automatically combines QCLKs when necessary

## ACTgen Counter

Several synthesis tools cannot build an optimal counter implementation for the Actel architecture. If a counter is on a critical path, this implementation can increase logic level usage and decrease performance. To reduce critical path delays and to achieve optimal results from your design, Actel recommends that you instantiate counters generated by the ACTgen Macro Builder. The ACTgen Macro Builder supports a wide variety of counters for area and performance needs.

The following example uses a 5-bit counter with load, count enable, and asynchronous reset that has been generated with ACTgen and saved as a structural HDL netlist called “CNT5”. The counter is instantiated as follows:

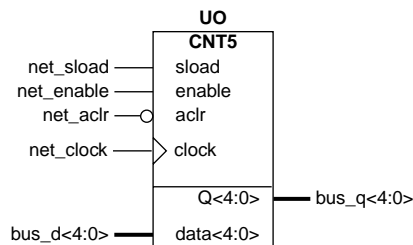

### VHDL

```

library IEEE;
use IEEE.std_logic_1164.all;

entity counter is
  port (bus_d : in std_logic_vector(4 downto 0);
        bus_q : out std_logic_vector(4 downto 0);
        net_clock, net_aclr, net_enable : in std_logic;
        net_sload : in std_logic);
end counter;

architecture rtl of counter is

  -- Component Declaration
  component CNT5
    port (Data : in std_logic_vector(4 downto 0);
          Sload, Enable, Aclr, Clock : in std_logic;
          Q : out std_logic_vector(4 downto 0));
  
```

```
end component;  
  
begin  
-- Concurrent Statement  
U0 : CNT5 port map (Data => bus_d,  
                   Sload => net_sload,  
                   Enable => net_enable,  
                   Aclr => net_aclr,  
                   Clock => net_clock,  
                   Q => bus_q);  
  
end rtl;
```

### Verilog

```
module counter (bus_q, bus_d, net_clock, net_aclr, net_enable,  
               net_sload);  
    input [4:0] data;  
    input net_sload, net_enable, net_aclr, net_clock;  
    output [4:0] bus_q;  
  
    CNT5 U0 (.Q(bus_q), .Data(bus_d), .Clock(net_clock), .Aclr(net_aclr),  
            .Enable(net_enable), .Sload(net_sload));  
  
endmodule
```

## Dual Architecture Coding in VHDL

It is possible to maintain technology independence after instantiating an ACTgen macro into your design. By adding a second technology independent architecture, you can maintain two functionally equivalent architectures of the same entity in your design. The ACTgen macro is Actel specific and instantiated in your design to take advantage of the architectural features of the target Actel FPGA. This allows you to meet your design goals quickly. The technology independent architecture is functionally equivalent to the Actel specific architecture (verified by simulation) and can be used to synthesize the design to another technology if necessary. The following example shows the technology independent (RTL) and Actel specific (structural) architecture for a counter called “CNT5” and illustrates how to write your code so that you can choose which architecture to use.

### RTL Architecture

This implementation of “CNT5” is written as a behavioral description directly into the design.

```
library IEEE;  
use IEEE.std_logic_1164.all;  
use IEEE.std_logic_unsigned.all;
```

```

entity CNT5 is
port    (Data: in std_logic_vector(4 downto 0);
          Sload, Enable, Aclr, Clock: in std_logic;
          Q: out std_logic_vector(4 downto 0));
end CNT5;

architecture RTL of CNT5 is

signal cnt: std_logic_vector(4 downto 0);

begin
counter : process (Aclr, Clock)
begin
if (Aclr = '0') then
    cnt <= (others => '0');           -- asynchronous reset
elsif (Clock'event and Clock = '1') then
    if (Sload = '1') then
        cnt <= Data;-- synchronous load
    elsif (Enable = '1') then
        cnt <= cnt + '1';           -- increment counter
    end if;
    end if;
end process;
Q <= cnt;           -- assign counter output to output port
end RTL;
    
```

## Structural Architecture

This implementation of “CNT5” is created by the ACTgen macro builder. The port names for the RTL description must match the port names of the structural “CNT5” netlist generated by ACTgen.

```

library ieee;
use ieee.std_logic_1164.all;
library ACT3;

entity CNT5 is
port (Data : in std_logic_vector(4 downto 0);Enable, Sload,
      Aclr, Clock : in std_logic; Q : out std_logic_vector(4
      downto 0)) ;
end CNT5;

architecture DEF_ARCH of CNT5 is

    component DFM7A
        port(D0, D1, D2, D3, S0, S10, S11, CLR, CLK : in
            std_logic; Q : out std_logic);
    end component;
    
```

```
. . .  
  
end DEF_ARCH;
```

## Instantiating “CNT5” in the Top Level Design

Once you have created both architectures, instantiate “CNT5” into your design, adding binding statements for both architectures. The binding statements are used to specify which architecture the synthesis tool uses in the design. The technology independent RTL architecture might not meet the performance requirements. The Actel specific DEF\_ARCH architecture is optimized for the Actel FPGA architecture and may provide higher performance. By removing the comment on one of the “use” statements in the code, a particular architecture can be chosen to meet the design needs.

```
library IEEE;  
use IEEE.std_logic_1164.all;  
  
entity counter is  
port (bus_d: in std_logic_vector(4 downto 0);  
      bus_q: out std_logic_vector(4 downto 0);  
      net_clock, net_aclr, net_enable: in std_logic;  
      net_sload: in std_logic);  
end counter;  
  
architecture RTL of counter is  
  
-- Component Declaration  
component CNT5  
port (Data : in std_logic_vector(4 downto 0); Enable, Sload,  
      Aclr, Clock : in std_logic; Q : out std_logic_vector(4  
      downto 0));  
end component;  
  
-- Binding statements to specify which CNT5 architecture to use  
-- RTL architecture for behavioral CNT5  
-- DEF_ARCH architecture for structural (ACTgen) CNT5  
-- for all: CNT5 use entity work.CNT5(RTL);  
-- for all: CNT5 use entity work.CNT5(DEF_ARCH);  
  
begin  
-- Concurrent Statement  
U0: CNT5 port map (Data => bus_d,  
                  Sload => net_sload,  
                  Enable => net_enable,  
                  Aclr => net_aclr;  
                  Clock => net_clock,  
                  Q => bus_q);
```

```
end rtl;
```

## SRAM

The following examples show how to create register-based SRAM for non-SRAM based Actel devices.

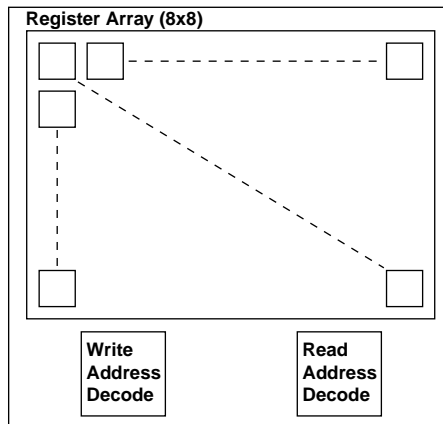

Figure 4-25. RAM Behavioral Simulation Model

### Register-Based Single Port SRAM

The following example shows the behavioral model for a 8x8 RAM cell. To modify the width or depth, simply modify the listed parameters in the code. The code assumes that you want to use “posedge clk” and “negedge reset.” Modify the “always” blocks if that is not the case.

#### VHDL

```
-- *****
-- Behavioral description of a single-port SRAM with:
--   Active High write enable (WE)
--   Rising clock edge (Clock)
-- *****

library ieee;
use ieee.std_logic_1164.all;
use IEEE.std_logic_arith.all;
use IEEE.std_logic_unsigned.all;

entity reg_sram is
```

```
    generic (width   : integer:=8;
            depth   : integer:=8;
            addr    : integer:=3);
    port (Data      : in std_logic_vector (width-1 downto 0);
         Q         : out std_logic_vector (width-1 downto 0);
         Clock     : in std_logic;
         WE        : in std_logic;
         Address   : in std_logic_vector (addr-1 downto 0));
end reg_sram;

architecture behav of reg_sram is
    type MEM is array (0 to depth-1) of std_logic_vector(width-1
    downto 0);
    signal ramTmp : MEM;
begin
    process (Clock)
    begin
        if (clock'event and clock='1') then
            if (WE = '1') then
                ramTmp (conv_integer (Address)) <= Data;
            end if;
        end if;
    end process;
    Q <= ramTmp(conv_integer(Address));
end behav;
```

### Verilog

```
`timescale 1 ns/100 ps
#####
/** Behavioral single-port SRAM description :
/**   Active High write enable (WE)
/**   Rising clock edge (Clock)
#####

module reg_sram (Data, Q, Clock, WE, Address);

    parameter width = 8;
    parameter depth = 8;
    parameter addr = 3;

    input Clock, WE;
    input [addr-1:0] Address;
    input [width-1:0] Data;
    output [width-1:0] Q;
    wire [width-1:0] Q;
    reg [width-1:0] mem_data [depth-1:0];

    always @(posedge Clock)
        if(WE)
            mem_data[Address] = #1 Data;

    assign Q = mem_data[Address];
```



```
endmodule
```

## Register-Based Dual-Port SRAM

The following example shows the behavioral model for a 8x8 RAM cell. This code was designed to imitate the behavior of the Actel DX family dual-port SRAM and to be synthesizable to a register based SRAM module. To modify the width or depth, modify the listed parameters in the code. The code assumes that you want to use “posedge clk” and “negedge reset.” Modify the “always” blocks if that is not the case.

### VHDL

```
-- Behavioral description of dual-port SRAM with :
--   Active High write enable (WE)
--   Active High read enable (RE)
--   Rising clock edge (Clock)

library ieee;
use ieee.std_logic_1164.all;
use IEEE.std_logic_arith.all;
use IEEE.std_logic_unsigned.all;

entity reg_dpram is
    generic (width      : integer:=8;
            depth      : integer:=8;
            addr       : integer:=3);
    port (Data      : in std_logic_vector (width-1 downto 0);
          Q         : out std_logic_vector (width-1 downto 0);
          Clock     : in std_logic;
          WE        : in std_logic;
          RE        : in std_logic;
          WAddress: in std_logic_vector (addr-1 downto 0);
          RAddress: in std_logic_vector (addr-1 downto 0));
end reg_dpram;

architecture behav of reg_dpram is
    type MEM is array (0 to depth-1) of std_logic_vector(width-1
    downto 0);
    signal ramTmp : MEM;
begin

    -- Write Functional Section

    process (Clock)
    begin
        if (clock'event and clock='1') then
            if (WE = '1') then
                ramTmp (conv_integer (WAddress)) <= Data;
            end if;
        end if;
    end process;
end architecture behav;
```

```
end process;

-- Read Functional Section

process (Clock)
begin
    if (clock'event and clock='1') then
        if (RE = '1') then
            Q <= ramTmp(conv_integer (RAddress));
        end if;
    end if;
end process;

end behav;
```

### Verilog

```
`timescale 1 ns/100 ps
//#####
//# Behavioral dual-port SRAM description :
//#   Active High write enable (WE)
//#   Active High read enable (RE)
//#   Rising clock edge (Clock)
//#####

module reg_dpram (Data, Q, Clock, WE, RE, WAddress, RAddress);

parameter width = 8;
parameter depth = 8;
parameter addr = 3;

input Clock, WE, RE;
input [addr-1:0] WAddress, RAddress;
input [width-1:0] Data;
output [width-1:0] Q;
reg [width-1:0] Q;
reg [width-1:0] mem_data [depth-1:0];

// #####
// # Write Functional Section
// #####
always @(posedge Clock)
begin
    if(WE)
        mem_data[WAddress] = #1 Data;
end

//#####
//# Read Functional Section
//#####
always @(posedge Clock)
begin
    if(RE)
```

```

                                Q = #1 mem_data[RAddress];
    end
    endmodule

```

## ACTgen RAM

The RAM cells in the 3200DX and 42 MX families of devices support asynchronous and synchronous dual-port RAM. The basic RAM cells can be configured as 32x8 or 64x4. However, most synthesis tools cannot infer technology specific features (such as RAM cells). The following example shows an ACTgen structural implementation for instantiation. Although the behavioral description is synthesizable, the implementation is not optimal for speed and area.

Using ACTgen, generate a 32x16 dual port RAM with the configuration shown in the figure below. Save the structured Verilog or VHDL implementations as “ram.”

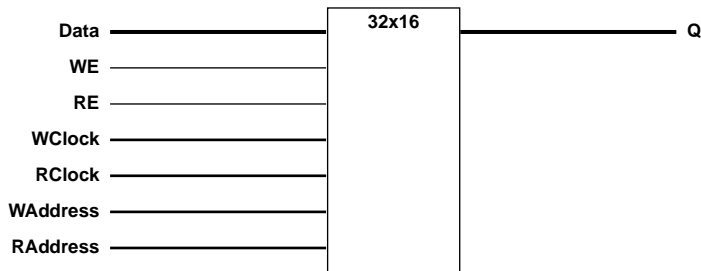

### VHDL

```

library IEEE;
use IEEE.std_logic_1164.all;
use IEEE.std_logic_unsigned.all;

entity ram32_16 is
    port (WAddress, RAddress:in std_logic_vector(4 downto 0);
          Data : in std_logic_vector (15 downto 0);
          Aclr, WClock, RClock,WE,RE:in std_logic;
          Q :out std_logic_vector (15 downto 0));
end ram32_16;

architecture rtl of ram32_16 is

    component ram
        port (Data : in std_logic_vector (15 downto 0);
              Aclr : in std_logic;
              WE : in std_logic ;
              RE : in std_logic ;
              WClock : in std_logic ;

```

```
        RClock : in std_logic ;
        WAddress : in std_logic_vector (4 downto 0);
        RAddress : in std_logic_vector (4 downto 0);
        Q       : out std_logic_vector (15 downto 0));
end component;

begin

R_32_16: ram
    port map (Data => Data,
              Aclr => Aclr,
              WE => WE,
              WAddress => WAddress,
              RE => RE,
              RAddress => RAddress,
              WClock => WClock,
              RClock => RClock,
              Q => Q);

end rtl;
```

### *Verilog*

```
module ram (WAddress, RAddress, Data, WClock, WE,
            RE, Rclock, Q);
    input [4:0] WAddress, RAddress;
    input [15:0] Data;
    input Rclock, WClock;
    input WE, RE;
    output [15:0] Q;

    ram R_32_16 (.Data(Data), .WE(WE), .RE(RE), .WClock(WClock),
                .Rclock(Rclock), .Q(Q), .WAddress(WAddress),
                .RAddress(RAddress));

endmodule
```

# FIFO

The following example shows how to create a register-based FIFO for non-SRAM based Actel devices.

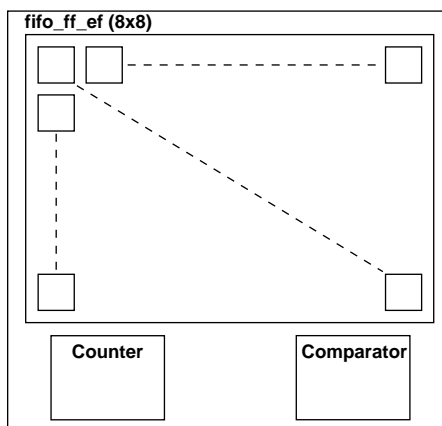

Figure 4-26. FIFO Behavioral Simulation Mode

## Register-Based FIFO

The following example show the behavioral model for an 8x 8 FIFO. This code was designed to imitate the behavior of the Actel DX family dual-port SRAM based FIFO and to be synthesizable to a register-based FIFO. To modify the width or depth, simply modify the listed parameters in the code. However, the code does assume that you want to use posedge clk and negedge reset. Modify the always blocks if that is not the case.

### VHDL

```

-- *****
-- Behavioral description of dual-port FIFO with :
--   Active High write enable (WE)
--   Active High read enable (RE)
--   Active Low asynchronous clear (Aclr)
--   Rising clock edge (Clock)
--   Active High Full Flag
--   Active Low Empty Flag
-- *****

library ieee;
use ieee.std_logic_1164.all;

```

```
use IEEE.std_logic_arith.all;

entity reg_fifo is

generic (width   : integer:=8;
        depth    : integer:=8;
        addr     : integer:=3);

port (Data      : in std_logic_vector (width-1 downto 0);
      Q         : out std_logic_vector (width-1 downto 0);
      Aclr      : in std_logic;
      Clock     : in std_logic;
      WE        : in std_logic;
      RE        : in std_logic;
      FF        : out std_logic;
      EF        : out std_logic);

end reg_fifo;

library ieee;
use ieee.std_logic_1164.all;
use IEEE.std_logic_arith.all;
use IEEE.std_logic_unsigned.all;

architecture behavioral of reg_fifo is

    type MEM is array(0 to depth-1) of std_logic_vector(width-1 downto 0);
    signal ramTmp      : MEM;
    signal WAddress   : std_logic_vector (addr-1 downto 0);
    signal RAddress   : std_logic_vector (addr-1 downto 0);
    signal words      : std_logic_vector (addr-1 downto 0);

begin

    -- #####
    -- # Write Functional Section
    -- #####

    WRITE_POINTER : process (Aclr, Clock)
    begin
        if (Aclr = '0') then
            WAddress <= (others => '0');
        elsif (Clock'event and Clock = '1') then
            if (WE = '1') then
                if (WAddress = words) then
                    WAddress <= (others => '0');
                else

```

```

        WAddress <= WAddress + '1';

        end if;
    end if;
end process;

WRITE_RAM : process (Clock)
begin
if (Clock'event and Clock = '1') then
    if (WE = '1') then
        ramTmp (conv_integer (WAddress)) <= Data;
    end if;
end if;
end process;

-- #####
-- # Read Functional Section
-- #####

READ_POINTER : process (Aclr, Clock)
begin
    if (Aclr = '0') then
        RAddress <= (others => '0');
    elsif (Clock'event and Clock = '1') then
        if (RE = '1') then
            if (RAddress = words) then
                RAddress <= (others => '0');
            else
                RAddress <= RAddress + '1';
            end if;
        end if;
    end if;
end process;

READ_RAM : process (Clock)
begin
    if (Clock'event and Clock = '1') then
        if (RE = '1') then
            Q <= ramTmp(conv_integer(RAddress));
        end if;
    end if;
end process;

-- #####
-- # Full Flag Functional Section : Active high

```

```
-- #####  
  
FFLAG : process (Aclr, Clock)  
begin  
  if (Aclr = '0') then  
    FF <= '0';  
  elsif (Clock'event and Clock = '1') then  
    if (WE = '1' and RE = '0') then  
      if ((WAddress = RAddress-1) or  
          ((WAddress = depth-1) and (RAddress = 0))) then  
        FF <= '1';  
      end if;  
    else  
      FF <= '0';  
    end if;  
  end if;  
end process;  
  
-- #####  
-- # Empty Flag Functional Section : Active low  
-- #####  
  
EFLAG : process (Aclr, Clock)  
begin  
  if (Aclr = '0') then  
    EF <= '0';  
  elsif (Clock'event and Clock = '1') then  
    if (RE = '1' and WE = '0') then  
      if ((WAddress = RAddress+1) or  
          ((RAddress = depth-1) and (WAddress = 0))) then  
        EF <= '0';  
      end if;  
    else  
      EF <= '1';  
    end if;  
  end if;  
end process;  
  
end behavioral;
```



### Verilog

```

`timescale 1 ns/100 ps
#####
/** Behavioral description of FIFO with :
/**   Active High write enable (WE)
/**   Active High read enable (RE)
/**   Active Low asynchronous clear (Aclr)
/**   Rising clock edge (Clock)
/**   Active High Full Flag
/**   Active Low Empty Flag
#####

module reg_fifo (Data, Q, Aclr, Clock, WE, RE, FF, EF);

parameter width = 8;
parameter depth = 8;
parameter addr = 3;

input Clock, WE, RE, Aclr;
input [width-1:0] Data;
output FF, EF; //Full & Empty Flags
output [width-1:0] Q;
reg [width-1:0] Q;
reg [width-1:0] mem_data [depth-1:0];
reg [addr-1:0] WAddress, RAddress;
reg FF, EF;

// #####
// # Write Functional Section
// #####
// WRITE_ADDR_POINTER
always @ (posedge Clock or negedge Aclr)
begin
    if(!Aclr)
        WAddress = #2 0;
    else if (WE)
        WAddress = #2 WAddress + 1;
end

// WRITE_REG
always @ (posedge Clock)
begin
    if(WE)
        mem_data[WAddress] = Data;
end

```

```
#####  
//# Read Functional Section  
#####  
// READ_ADDR_POINTER  
always @ (posedge Clock or negedge Aclr)  
begin  
    if(!Aclr)  
        RAddress = #1 0;  
    else if (RE)  
        RAddress = #1 RAddress + 1;  
end  
  
// READ_REG  
always @ (posedge Clock)  
begin  
    if (RE)  
        Q = mem_data[RAddress];  
end  
  
#####  
//# Full Flag Functional Section : Active high  
#####  
always @ (posedge Clock or negedge Aclr)  
begin  
    if(!Aclr)  
        FF = #1 1'b0;  
    else if ((WE & !RE) && ((WAddress == RAddress-1) ||  
        ((WAddress == depth-1) && (RAddress == 1'b0))))  
        FF = #1 1'b1;  
    else  
        FF = #1 1'b0;  
end  
  
#####  
//# Empty Flag Functional Section : Active low  
#####  
always @ (posedge Clock or negedge Aclr)  
begin  
    if(!Aclr)  
        EF = #1 1'b0;  
    else if ((!WE & RE) && ((WAddress == RAddress+1) ||  
        ((RAddress == depth-1) && (WAddress == 1'b0))))  
        EF = #1 1'b0;  
    else  
        EF = #1 1'b1;  
end  
  
endmodule
```

## ACTgen FIFO

The RAM cells in the 3200DX and 42MX families of devices can be used to implement a variety of FIFOs. The behavioral description of a 32x8 FIFO for simulation is shown below. However, most synthesis tools cannot infer technology specific features such as RAM cells. Synthesizing this model will result in high area utilization. ACTgen can generate an area and performance optimized structured HDL netlist for instantiation.

Using ACTgen, generate a 32x8 FIFO with the configuration shown in the figure below. Save it as a Verilog or VHDL netlist called “fifo\_ff\_ef.”

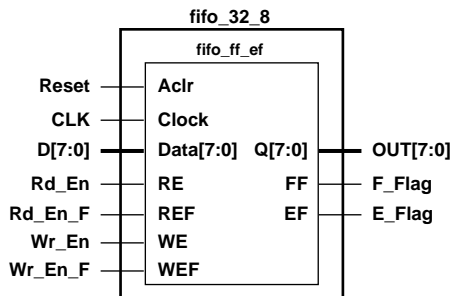

### VHDL

```

library IEEE;
use IEEE.std_logic_1164.all;

entity fifo_32_8 is
port (D
      : in std_logic_vector(7 downto 0);
      OUT
      : out std_logic_vector(7 downto 0);
      Reset
      : in std_logic;
      Rd_En, Wr_En
      : in std_logic;
      Rd_En_F, Wr_En_F
      : in std_logic;
      clk
      : in std_logic;
      E_Flag, F_Flag
      : out std_logic);
end fifo_32_8;

architecture fifo_arch of fifo_32_8 is
  component fifo_ff_ef
    generic (width : integer;
            depth  : integer;
            clrPola : integer;
            clkEdge : integer);
    port (Data : in std_logic_vector (width-1 downto 0);
          Aclr : in std_logic;
          WE   : in std_logic ;

```

```
        WEF      : in std_logic ;
        RE       : in std_logic ;
        REF      : in std_logic ;
        Clock    : in std_logic ;
        Q        : out std_logic_vector (width-1 downto 0);
        FF       : out std_logic;
        EF       : out std_logic);

    end component;

begin

F_32_8: fifo_ff_ef
    generic map (width => 8, depth => 32, clrPola => 1,
                clkEdge => 1)
    port map (Data => D,
              Aclr => Reset,
              WE => We_En,
              WEF => We_En_F,
              RE => Rd_En,
              REF => Rd_En_F,
              Clock => CLK,
              Q => OUT,
              FF => F_Flag,
              EF => E_Flag);

end fifo_arch;
```

### *Verilog*

```
module fifo_32_8 (D, OUT, Reset, Rd_En, Wr_En, CLK, E_Flag,
                 Rd_En_F, Wr_En_F, F_Flag);
    input        [7:0] D;
    output       [7:0] OUT;
    input        Reset;
    input        Rd_En;
    input        Rd_En_F;
    input        Wr_En;
    input        Wr_En_F;
    input        CLK;
    output       E_Flag;
    output       F_Flag;
    wire         [7:0] OUT;
    wire         E_Flag;
    wire         F_Flag;

    fifo_ff_ef F_32_8 (.Data(D), .Aclr(Reset), .WE(Wr_En),
                     .WEF(Wr_En_F), .RE(Rd_En), .REF(Rd_En_F)
                     .Clock(CLK), .Q(OUT), .FF(F_Flag), .EF(E_Flag));

endmodule
```

---

# Product Support

Actel backs its products with various support services including Customer Service, a Customer Technical Support Center, a web site, an FTP site, electronic mail, and worldwide sales offices. This appendix contains information about contacting Actel and using these support services.

## Customer Service

Contact Customer Service for non-technical product support, such as product pricing, product upgrades, update information, order status, and authorization.

From Northeast and North Central U.S.A., call **650.318.4480**

From Southeast and Southwest U.S.A., call **650.318.4480**

From South Central U.S.A., call **650.318.4434**

From Northwest U.S.A., call **650.318.4434**

From Canada, call **650.318.4480**

From Europe, call **650.318.4252** or **+44 (0)1276.401500**

From Japan, call **650.318.4743**

From the rest of the world, call **650.318.4743**

Fax, from anywhere in the world **650.318.8044**

## Actel Customer Technical Support Center

Actel staffs its Customer Technical Support Center with highly skilled engineers who can help answer your hardware, software, and design questions. The Customer Technical Support Center spends a great deal of time creating application notes and answers to FAQs. So, before you contact us, please visit our online resources. It is very likely we have already answered your questions.

## Actel Technical Support

Visit the [Actel Customer Support website \(www.actelcom/.custsup/search.html\)](http://www.actelcom/.custsup/search.html) for more information and support. Many answers available on the searchable web resource include diagrams, illustrations, and links to other resources on the Actel web site.

## Website

You can browse a variety of technical and non-technical information on Actel's [home page](http://www.actel.com), at [www.actel.com](http://www.actel.com).

---

## Contacting the Customer Technical Support Center

Highly skilled engineers staff the Technical Support Center from 7:00 A.M. to 6:00 P.M., Pacific Time, Monday through Friday. Several ways of contacting the Center follow:

### Email

You can communicate your technical questions to our email address and receive answers back by email, fax, or phone. Also, if you have design problems, you can email your design files to receive assistance. We constantly monitor the email account throughout the day. When sending your request to us, please be sure to include your full name, company name, and your contact information for efficient processing of your request.

The technical support email address is [tech@actel.com](mailto:tech@actel.com).

### Phone

Our Technical Support Center answers all calls. The center retrieves information, such as your name, company name, phone number and your question, and then issues a case number. The Center then forwards the information to a queue where the first available application engineer receives the data and returns your call. The phone hours are from 7:00 A.M. to 6:00 P.M., Pacific Time, Monday through Friday. The Technical Support numbers are:

**650.318.4460**

**800.262.1060**

Customers needing assistance outside the US time zones can either contact technical support via email ([tech@actel.com](mailto:tech@actel.com)) or contact a local sales office. [Sales office listings](#) can be found at [www.actel.com/contact/offices/index.html](http://www.actel.com/contact/offices/index.html).

---

# Index

- A**
- ACT 3 I/O 87
- Actel
  - web site 109
  - web-based technical support 109
- Actel Manuals 11
- ACTgen
  - Counter Instantiation 91
  - FIFO 107
  - RAM 99
- Addition 44
- Arithmetic Operator 44
  - Shift Register Implementation 45
- Assumptions 7
  
- B**
- Behavioral Simulation 16
- BREPTH 87
  
- C**
- Capturing a Design 16
- Case Statement 34, 77
  - Adding Directive 77
- CLKBUF 88
- CLKINT 88
- Coding Dual Architecture 92
  - Instantiating 94
  - RTL 92
  - Structural 93
- Combinatorial/Sequential Module Merging 71
- Combining Logic 68, 71
- Component
  - Size 63
  - Width 63
- Contacting Actel
  - customer service 109
  - electronic mail 110
  - telephone 110
  - web-based technical support 109
- Conventions 8
  - Document 8
  - Naming, Verilog 9
  - Naming, VHDL 8
- Counter 40–43
  - 8-Bit, Count Enable, Asynchronous Reset 40
  - 8-Bit, Load and Asynchronous Reset 41
  - 8-Bit, Load, Count Enable, Terminal Count and Asynchronous Reset 42
  - Instantiation 91
  - N-Bit, Load, Count Enable, and Asynchronous Reset 43
  - Recommendations 40, 91
- Critical Path Logic Reduction 65
- Customer service 109
  
- D**
- Data Shift 48
- Datapath 33–49
  - Arithmetic Operator 44
  - Counter 40
  - Decoder 39
  - Equality Operator 46
  - If-Then-Else 33
  - Multiplexor 34
  - Relational Operator 45
  - Shift Operator 48
- Decoder 39
- Design Creation/Verification 16
  - Behavioral Simulation 16
  - EDIF Netlist Generation 16
  - HDL Source Entry 16
  - Structural Netlist Generation 17

- 
- Structural Simulation 17
  - Synthesis 16
  - Design Flow
    - Design Creation/Verification 16
    - Design Implementation 17
    - Programming 17
    - System Verification 18
  - Design Implementation 17
    - Place and Route 17
    - Timing Analysis 17
    - Timing Simulation 17
  - Design Layout 17
  - Design Partitioning 75
  - Design Synthesis 16
  - Designer
    - DT Analyze Tool 17
    - Place and Route 17
    - Timing Analysis 17
  - Device Programming 17
  - DFPC Cell 87
  - Division 44
  - D-Latch 19–31
    - with Asynchronous Reset 30
    - with Data and Enable 27
    - with Gated Asynchronous Data 28
    - with Gated Enable 29
  - Document
    - Assumptions 7
    - Conventions 8
    - Organization 7
  - Document Conventions 8
  - Don't Care 38
  - DT Analyze 17
  - Dual Architecture Coding 92
    - Instantiating 94
    - RTL 92
    - Structural 93
  - Dual Port SRAM 97, 99
  - Duplicating Logic 72
- E**
- Edge-Triggered Memory Device 19
  - EDIF Netlist Generation 16
  - Electronic mail 110
  - Equality Operator 46
- F**
- Fanout
    - High Fanout Networks 88, 90
    - Reducing 72
  - FIFO 101–108
    - ACTgen Implementation 107
    - Behavioral Implementation 101
    - Register-Based 101
    - Structural Implementation 107
  - Finite State Machine 49–58
    - Combinational Next State Logic 49
    - Combinational Output Logic 49
    - Mealy 51
    - Moore 55
    - One Hot 50
    - Sequential Current State Register 49
    - Structure 50
  - Flip-Flop 19–27
    - See Also* Register
    - Positive Edge Triggered 19
      - with Asynchronous Preset 21
      - with Asynchronous Reset 20
      - with Asynchronous Reset and Clock Enable 26
      - with Asynchronous Reset and Preset 23
      - with Synchronous Preset 25
      - with Synchronous Reset 24



---

FSM. *See* Finite State Machine

## G

Gate-Level Netlist 16

Generating

EDIF Netlist 16

Gate-Level Netlist 16

Structural Netlist 17

Generics 63–64

Greater Than 45

Greater Than Equal To 45

## H

HDL Design Flow

Design Creation/Verification 16

Design Implementation 17

Programming 17

System Verification 18

HDL Source Entry 16

## I

If-Then-Else Statement 33

Input-Output Buffer 58–63

Bi-Directional 61

Tri-State 59

Instantiating

CLKBUF Driver 88

CLKINT Driver 88

Counters 91

Dual Coding 92

FIFO 107

QCLKBUF Driver 90

QCLKINT Driver 90

RAM 99

Registered I/Os 87

Internal Tri-State Mapping 77

Internally Generated Clock 88, 90

## K

Keywords

Verilog 9

VHDL 8

## L

Latch 19

Master 87

Slave 87

Less Than 45

Less Than Equal To 45

Level-Sensitive Memory Device 19

Load Reduction 72

Logic Level Reduction 65

Loops 70

## M

Merging Logic Modules 71

Module Block Partitioning 75

Multiplexor 34, 77

Case X 38

Four to One 35

Mapping Internal Tri-State to 77

Moving Operators Outside Loops 70

Twelve to One 36

Multiplication 44

## N

Naming Conventions

Verilog 9

VHDL 8

Netlist Generation

EDIF 16

Gate-Level 16

---

Structural 17

## O

One Hot State Machine 50

Online Help 13

Operators 31

Arithmetic 44

Equality 46

Inside Loops 70

Relational 45

Removing from Loops 70

Shift 48

Table of 31

## P

Parallel

Encoding 34

Operation 77

Parameters 63–64

Partitioning a Design 75

Performance Driven Coding 65–76

Place and Route 17

Priority Encoding 33

Product Support 109–110

Product support

customer service 109

electronic mail 110

technical support 109

web site 109

Programming a Device 17

## Q

QCLKBUF 90

QCLKINT 90

Quadrant Clock 90

Limitations 91

## R

RAM 99

Reducing Fanout 72

Reducing Logic

on a Critical Path 65

Usage 68

Register 80

*See Also* Flip-Flop

Asynchronous Preset 84

Asynchronous Preset and Clear 87

Clock Enabled 82

Duplication 72

Functionally Equivalent Asynchronous Preset  
84

Placed at Hierarchical Boundaries 75

Recommended Usage 80–87

Synchronous Clear or Preset 81

Register-Based

FIFO 101

SRAM 95–99

Dual Port 97

Single Port 95

Registered I/O 87

BREPTH 87

Related Manuals 12

Relational Operator 45

Removing Operators from Loops 70

Reset Signals 88, 90

Resource Sharing 68

## S

Sequential Device 19–27

D-Latch 19

Flip-Flop 19

Sharing Resources 68

Shift

---

Operator 48  
Register 45  
Simulation  
  Behavioral 16  
  Structural 17  
  Timing 17  
Single Port SRAM 95  
Size 63  
SRAM 95–100  
  ACTgen Implementation 99  
  Dual Port 97  
  Register Based 95  
  Single Port 95  
  Structural Implementation 99  
Static Timing Analysis 17  
Structural Netlist Generation 17  
Structural Simulation 17  
Subtraction 44  
Synthesis 16  
  Reducing Duration of 75  
System Verification, Silicon Explorer 18

## *T*

Technology Independent Coding 19–64  
Technology Specific Coding 77–108  
Timing  
  Analysis 17  
  Constraints 65  
  Simulation 17  
Tri-State Mapping 77  
True/False Operands 46

## *U*

Unit Delays 16

## *V*

Verilog  
  Naming Conventions 9  
  Reserved Words 9  
VHDL  
  Naming Conventions 8  
  Reserved Words 8

## *W*

Web-based technical support 109  
Width 63

***For more information about Actel's products, visit our website at  
<http://www.actel.com>***

***Actel Corporation*** • 2061 Stierlin Court • Mountain View, CA 94043 USA  
Customer Service: 650.318.1010 • Customer Applications Center: 800.262.1060

***Actel Europe Ltd.*** • Dunlop House, Riverside Way • Camberley, Surrey GU15 3YL • United Kingdom  
Phone +44 (0)1276.401452 • Fax +44 (0)1276.401490

***Actel Japan*** • EXOS Ebisu Bldg. 4F • 1-24-14 Ebisu Shibuya-ku • Tokyo 150 • Japan  
Phone +81.03.3445.7671 Fax +81.03.3445.7668

***Actel Hong Kong*** • 39<sup>th</sup> Floor, One Pacific Place • 88 Queensway, Admiralty Hong Kong  
Phone +852.227.35712 Fax +852.227.35999

5029105-6/05.04

