

---

# *Activator and APS Programming System*

## *Installation and User's Guide*



*Windows and UNIX Environments*

---

## **Actel Corporation, Sunnyvale, CA 94086**

© 1998 Actel Corporation. All rights reserved.

Printed in the United States of America

Part Number: 5029102-1

Release: May 1999

No part of this document may be copied or reproduced in any form or by any means without prior written consent of Actel. Actel makes no warranties with respect to this documentation and disclaims any implied warranties of merchantability or fitness for a particular purpose. Information in this document is subject to change without notice. Actel assumes no responsibility for any errors that may appear in this document. This document contains confidential proprietary information that is not to be disclosed to any unauthorized person without prior written consent of Actel Corporation.

### Trademarks

Actel and the Actel logotype are registered trademarks of Actel Corporation.

Adobe and Acrobat Reader are registered trademarks of Adobe Systems, Inc.

Adaptec is a registered trademark of Adaptec Inc.

AT is a registered trademark of IBM Corporation.

Cadence is a registered trademark of Cadence Design Systems, Inc.

HP-UX is a registered trademark of Hewlett Packard Company.

Intel and Pentium are registered trademarks of Intel Corporation.

Mentor Graphics is registered trademark of Mentor Graphics, Inc.

Microsoft, Windows and Windows NT are trademarks or registered trademark of Microsoft Corporation.

Solaris and SunOS are trademarks or registered trademarks of Sun Microsystems, Inc.

Synopsys a registered trademark of Synopsys, Inc.

UNIX is a registered trademark of X/Open Company Limited.

Verilog is a registered trademark of Open Verilog International.

Viewlogic and Workview are registered trademarks and MOTIVE is a trademark of Viewlogic Systems, Inc.

All other products or brand names mentioned are trademarks or registered trademarks of their respective holders.

---

# Table of Contents

Introduction . . . . .	ix
Document Organization . . . . .	ix
Document Assumptions . . . . .	x
Document Conventions . . . . .	x
Actel Manuals . . . . .	x
On-Line Help . . . . .	xiii
<b>1 Hardware Description . . . . .</b>	<b>1</b>
Unpacking Your Activator . . . . .	1
Device Handling . . . . .	1
Activator 2 and 2s Rear Panels . . . . .	2
Adapter Modules . . . . .	4
PC Adaptec AVA-1505A AT-to-SCSI Host Adapter . . . . .	4
<b>2 Hardware Installation on a PC . . . . .</b>	<b>7</b>
Adaptec AVA-1505A AT-to-SCSI Host Adapter Installation . . . . .	7
Installing the 1505A Card Under Windows 95 . . . . .	8
Installing the 1505A Card Under Windows NT. . . . .	11
Connecting an Adaptec SCSI Card to the Activator. . . . .	14
Installing the Activator. . . . .	15
Installing and Removing an Adapter Module . . . . .	17
<b>3 Hardware Installation on a Workstation . . . . .</b>	<b>19</b>
Installing an Activator on a SunOS Workstation . . . . .	19
Installing an Activator on a Solaris Workstation . . . . .	21
Installing an Activator on an HP-UX Workstation . . . . .	24
Installing and Removing an Adapter Module . . . . .	26
<b>4 Programming an Actel Device . . . . .</b>	<b>27</b>
Programming Flow . . . . .	27
APSW Description . . . . .	28
Programming a Device with APSW . . . . .	31
Programming Security Fuses . . . . .	34

<b>5</b>	<b>Device Programming Failure Guidelines</b>	41
	Programming Failure Guidelines	41
	Activator Programming Failures	42
	Returning Failed Devices	42
<b>6</b>	<b>Verifying a Device with an Activator</b>	43
	Functional Verification with an Activator	43
	Running Debugger From APSW	44
	Debugger Command-Line Commands	45
	Using Command Files to Verify a Device	49
<b>A</b>	<b>Troubleshooting</b>	55
	Driver Does Not Load under Windows	55
	Activator	55
	AFM File	57
	Fuse	57
	SCSI Controller	58
	Fuse Failures	59
	Error Messages	59
	Silicon Explorer	60
<b>B</b>	<b>AVI File Description</b>	63
<b>C</b>	<b>Product Support</b>	65
	Actel U.S. Toll-Free Line	65
	Customer Service	65
	Customer Applications Center	66
	Guru Automated Technical Support	66
	Web Site	66
	FTP Site	67
	Electronic Mail	67
	Worldwide Sales Offices	68
	<b>Index</b>	69

---

## List of Figures

Activator 2 Rear Panel Connectors . . . . .	2
Activator 2s Rear Panel Connectors . . . . .	3
Adaptec AVA-1505A AT-to-SCSI Host Adapter . . . . .	5
Activator 2 and 2s PC Connections . . . . .	16
Power Supply Connected to Activator 2s . . . . .	16
Activator 2 and 2s Workstation Connections . . . . .	20
APSW Main Window . . . . .	28
Activate Options for ACT 1 and 40MX Devices . . . . .	34
Activate Options for all Other Devices . . . . .	34



---

## *List of Tables*

ACT 1 and 40MX Security Fuse Configurations . . . . .	35
Non ACT 1/40MX Security Fuse Configurations . . . . .	37
Command-Line Commands and Functions . . . . .	45





---

# Introduction

The *Activator and APS Programming System Installation and User's Guide* contains information about programming Actel devices using an Activator device programmer and the APS programming software. The guide is divided into two main sections: Activator installation and setup instructions and APS software usage. The installation and setup instructions include information about installing the Activator device programmers and the Adaptec AVA™-1505A AT®-to-SCSI host adapter (1505A card). The APS software usage section contains information about using an Activator with the APS programming software to program and verify Actel devices.

## Document Organization

The *Activator and APS Programming System Installation and User's Guide* is divided into the following chapters:

**Chapter 1 - Hardware Description** contains hardware handling procedures and descriptions of the Activator 2, 2s, and the 1505A card.

**Chapter 2 - Hardware Installation on a PC** contains information and procedures to install an Activator on a PC.

**Chapter 3 - Hardware Installation on a Workstation** contains information and procedures to install an Activator on a UNIX workstation.

**Chapter 4 - Programming an Actel Device** contains information and procedures to program Actel devices using APS programming software.

**Chapter 5 - Device Programming Failure Guidelines** describes conditions that can cause an Actel device to fail.

**Chapter 6 - Verifying a Device with an Activator** contains information and procedures to verify Actel devices using an Activator and APS programming software.

**Chapter 7 - Silicon Explorer Diagnostic Tool** contains information and procedures to use the Silicon Explorer Diagnostic Tool.

**Appendix A - Troubleshooting** describes some common hardware and software problems and solutions to those problems.

**Appendix B - AVI File description** contains a description of an AVI log file.

**Appendix C - Product Support** provides information about contacting Actel for customer and technical support.

## Document Assumptions

The information in this manual is based on the following assumptions:

1. You have installed the Designer Series software, including APSW.
2. You are familiar with UNIX workstations and UNIX operating systems, or with PCs and Windows operating environments.
3. You are familiar with FPGA architecture and FPGA design software.

## Document Conventions

The following conventions are used throughout this manual.

Information that is meant to be input by the user is formatted as follows:

**keyboard input**

The contents of a file is formatted as follows:

file contents

Messages that are displayed on the screen appear as follows:

Screen Message
----------------

## Actel Manuals

The Designer Series software includes printed and on-line manuals. The on-line manuals are in PDF format on the CD-ROM in the “/manuals” directory. These manuals are also installed onto your

system when you install the Designer software. To view the on-line manuals, you must install Adobe® Acrobat Reader® from the CD-ROM.

The Designer Series includes the following manuals, which provide additional information on designing Actel FPGAs:

*Designing with Actel.* This manual describes the design flow and user interface for the Actel Designer Series software, including information about using the ACTgen Macro Builder and ACTmap VHDL Synthesis software.

*Actel HDL Coding Style Guide.* This guide provides preferred coding styles for the Actel architecture and information about optimizing your HDL code for Actel devices.

*ACTmap VHDL Synthesis Methodology Guide.* This guide contains information, optimization techniques, and procedures to assist designers in the design of Actel devices using ACTmap VHDL.

*Silicon Expert User's Guide.* This guide contains information and procedures to assist designers in the use of Actel's Silicon Expert tool.

*DeskTOP Interface Guide.* This guide contains information about using the integrated VeriBest® and Synplicity® CAE software tools with the Actel Designer Series FPGA development tools to create designs for Actel Devices.

*Cadence® Interface Guide.* This guide contains information and procedures to assist designers in the design of Actel devices using Cadence CAE software and the Designer Series software.

*Mentor Graphics® Interface Guide.* This guide contains information and procedures to assist designers in the design of Actel devices using Mentor Graphics CAE software and the Designer Series software.

*MOTIVE™ Static Timing Analysis Interface Guide.* This guide contains information and procedures to assist designers in the use of the MOTIVE software to perform static timing analysis on Actel designs.

*Synopsys® Synthesis Methodology Guide.* This guide contains preferred HDL coding styles and information and procedures to assist designers in the design of Actel devices using Synopsys CAE software and the Designer Series software.

*Viewlogic Powerview® Interface Guide.* This guide contains information and procedures to assist designers in the design of Actel devices using Powerview CAE software and the Designer Series software.

*Viewlogic Workview Office Interface Guide.* This guide contains information and procedures to assist designers in the design of Actel devices using Workview Office CAE software and the Designer Series software.

*VHDL Vital Simulation Guide.* This guide contains information and procedures to assist designers in simulating Actel designs using a Vital compliant VHDL simulator.

*Verilog Simulation Guide.* This guide contains information and procedures to assist designers in simulating Actel designs using a Verilog simulator.

*Activator and APS Programming System Installation and User's Guide.* This guide contains information about how to program and debug Actel devices, including information about using the Silicon Explorer diagnostic tool for system verification.

*Silicon Sculptor User's Guide.* This guide contains information about how to program Actel devices using the Silicon Sculptor software and device programmer.

*Silicon Explorer Quick Start.* This guide contains information about connecting the Silicon Explorer diagnostic tool and using it to perform system verification.

*Designer Series Development System Conversion Guide UNIX® Environments.* This guide describes how to convert designs created in Designer Series versions 3.0 and 3.1 for UNIX to be compatible with later versions of Designer Series.

*Designer Series Development System Conversion Guide Windows Environments.* This guide describes how to convert designs created in Designer Series versions 3.0 and 3.1 for Windows to be compatible with later versions of Designer Series.

*Actel FPGA Data Book.* This guide contains detailed specifications on Actel device families. Information such as propagation delays, device

package pinout, derating factors, and power calculations are found in this guide.

*Macro Library Guide.* This guide provides descriptions of Actel library elements for Actel device families. Symbols, truth tables, and module count are included for all macros.

*A Guide to ACTgen Macros.* This Guide provides descriptions of macros that can be generated using the Actel ACTgen Macro Builder software.

## On-Line Help

The Designer Series software comes with on-line help. On-line help specific to each software tool is available in Designer, ACTgen, ACTmap, Silicon Expert, Silicon Explorer, Silicon Sculptor, and APSW.



---

## *Hardware Description*

This chapter contains device handling guidelines and descriptions of the Activator 2, 2s, Adaptec AVA-1505A AT-to-SCSI host adapter (1505A card), and Adapter Module. The Activator 2 or 2s programmers and the Adapter Module, and the 1505A card if you are using a PC, are used when programming Actel devices.

### *Unpacking Your Activator*

Unpack your Activator carefully and set it up in a clean operating environment. Never expose the unit to excessive heat, such as direct sunlight or heating vents and other heat-generating devices. Make sure you allow adequate ventilation on all four sides of the unit. The programmer is also equipped with rubber feet to raise it above the operating surface, allowing further ventilation. Make sure you do not block ventilation to the bottom of the unit.

### *Device Handling*

Actel devices are CMOS devices and require proper grounding and Electro Static Device (ESD) handling procedures. Although all Actel parts have static discharge protection built in, you should always follow ESD handling procedures when handling Actel devices.

You should always wear grounded wrist straps at an ESD workstation when handling devices. A calibrated ionizer should be on and functioning properly at the workstation. An ionizer air stream should be directed over the parts at all times.

Always keep the devices in their anti-static carrying cases until they are used, and keep the surrounding environment clean and free of dust and debris. Periodically check the Adapter Module sockets to make sure that they are free of dirt or other debris that would prevent good electrical pin connections between the device and socket.

When loading a device in the Adapter Module socket, be sure that pin 1 on the device is oriented according to the diagram on the Adapter Module. Damage can occur if the FPGA is loaded incorrectly.

## Activator 2 and 2s Rear Panels

The Activator 2 is a four-device programmer, with interchangeable Adapter Modules that support all of Actel's device packages. The Activator 2s is a single socket version of the Activator 2.

This section describes and illustrates the connectors on the rear panels of the Activator 2 and 2s. The connectors are shown in Figure 1-1 below and Figure 1-2 on page 3.

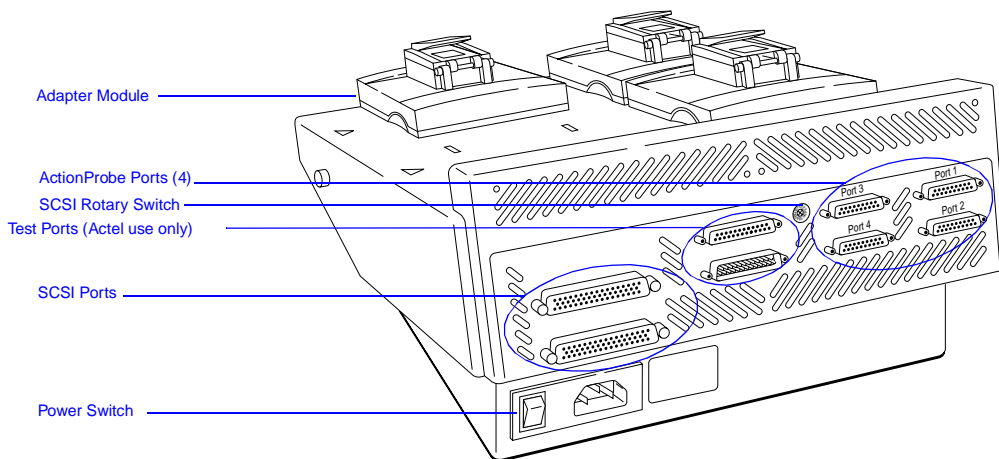

Figure 1-1. Activator 2 Rear Panel Connectors

### Common Connectors

The following connectors are common to the Activator 2 and 2s.

#### ActionProbe Port

The ActionProbe Port supports in-circuit verification using the ActionProbe diagnostic tool. The Activator 2s has one port. The Activator 2 has four ports, one for each programming socket. The ActionProbe has been replaced with the Silicon Explorer, which uses a serial port. If you are using an ActionProbe, refer to the documentation included with it for information about using the ActionProbe tool.



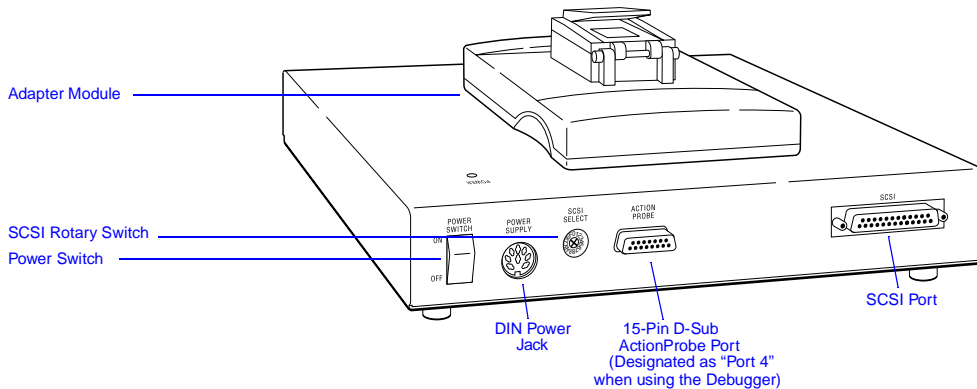

Figure 1-2. Activator 2s Rear Panel Connectors

### **Adapter Module**

The Adapter Module is plugged into the Activator and used to program Actel devices. The Activator 2s can accept one Adapter Module. The Activator 2 can accept four. Refer to “Adapter Modules” on page 4 for information about Adapter Modules.

### **Power Switch**

The power switch is used to turn the Activator on and off.

### **SCSI Rotary Switch**

The SCSI rotary switch is used to select the SCSI bus ID. Refer to Chapter 2, “Hardware Installation on a PC” on page 7 or Chapter 3, “Hardware Installation on a Workstation” on page 19 for information about setting the SCSI rotary switch.

### **SCSI Port**

The SCSI port is used to communicate with the computer through the SCSI interface. The Activator 2s has one SCSI port. The Activator 2 has two ports that are connected in parallel.

## **Activator 2 Connectors**

In addition to the common connectors, the Activator 2 has the following connector.

### **Test Port**

The two Test Ports are used for factory diagnostic testing and are not available for customer use. Do not connect any devices to these ports.

## **Activator 2s Connectors**

In addition to the common connectors, the Activator 2s has the following connector:

### **DIN Power Jack**

The DIN power jack is used to connect the power supply (supplied by Actel) to the Activator 2s.

## **Adapter Modules**

The Activator 2 has four sockets for Adapter Modules and can program up to four Actel devices simultaneously. The Activator 2s has one socket for a single Adapter Module. Each device package type has an Adapter Module designed specifically for that device. Contact your local sales representative for availability of Adapter Modules.

If the Adapter Module does not match the package type of the design being programmed, the APS software displays the message “wrong adapter type” for each incorrect socket. In each case, replace the wrong adapter with the correct one. Refer to “Installing and Removing an Adapter Module” on page 17 or page 26 for information about installing and removing Adapter Modules from an Activator.

## **PC Adaptec AVA-1505A AT-to-SCSI Host Adapter**

The 1505A card, included with the Activator, interfaces with the Activator 2 or 2s. The 1505A card, shown in Figure 1-3, has an external 25-pin DB25 SCSI connector.

A jumper block (J3) is located on the left-center of the 1505A card. This block is used to configure the I/O address, if necessary. The default I/O address is 340H-35FH.

The external 25-pin DB25 edge connector can be confused with a parallel port connector. Make sure you plug the Activator into the 25-pin DB25 connector on the 1505A card.

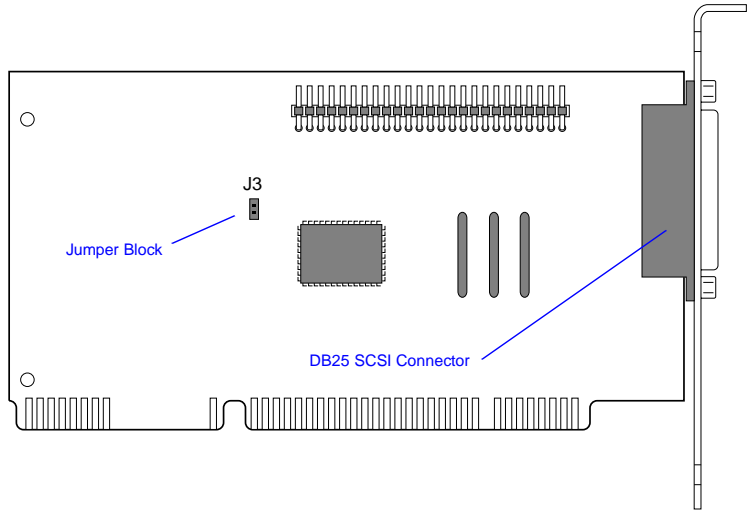

Figure 1-3. Adaptec AVA-1505A AT-to-SCSI Host Adapter



---

## *Hardware Installation on a PC*

This chapter contains information and procedures to install an Activator 2 or 2s on a PC, including information about configuring your 1505A card, installing the appropriate software driver(s), hooking up an Activator and installing and removing an Adapter Module. Refer to the *Adaptec AVA-1505A AT-to-SCSI Host Adapter Installation Guide* (Actel part number AVA-1505A, included with the 1505A card) for additional information about installing and configuring the 1505A card.

### *Adaptec AVA-1505A AT-to-SCSI Host Adapter Installation*

This section contains background information and describes the procedures for installing and configuring the 1505A card on a PC. If your PC already contains an Adaptec SCSI host adapter card, you can use it instead of installing the 1505A card provided by Actel. Go to “Connecting an Adaptec SCSI Card to the Activator” on page 14 for configuration information.

#### ***Background Information***

PCs use interrupt numbers (IRQs) and I/O addresses to distinguish between different add-in cards. Each add-in card must be assigned a IRQ and I/O address. If more than one card uses the same IRQ or address, conflicts between the cards may occur. Newer Plug and Play cards can be configured by software to use unique IRQs and I/O addresses. However, non-Plug and Play, or legacy, cards cannot. When installing a legacy card, the user must determine what IRQs and I/O addresses are in use by the other cards in the PC so that a unique IRQ and I/O address can be selected for the legacy card. The 1505A card is a plug and play card.

All PCs (486 and newer) contain an ISA (or AT) bus. Additionally, Pentium® PCs usually include an additional bus, the PCI bus, used for Plug and Play cards. The 1505A card uses the ISA bus, not the PCI bus.

## **Installation Steps**

Regardless of which Windows operating environment you are working under (95 or NT), you must perform the following steps to successfully install the 1505A card into a PC:

1. Select a unique I/O address for the 1505A card.
2. Install the 1505A card into your PC.
3. Configure the software driver(s), with the I/O address of the driver(s) matching the I/O address set on the 1505A card.
4. If an Activator is sharing the 1505A card with other SCSI devices, configure the termination resistors on the 1505A card and the other SCSI devices.
5. Connect the Activator to the 1505A card.

## *Installing the 1505A Card Under Windows 95*

This section describes how to install the 1505A card under Windows 95.

### **Select a Unique IRQ and I/O Address**

The default settings on the 1505A card should work. However, you may have an add-in card installed on your PC with IRQ and I/O address settings that conflict with the default settings on the 1505A card. The conflict may affect your video, network connection, or hard drive. If there is a conflict, you must change the IRQ and I/O address of either the 1505A card or an installed add-in card.

*To select the I/O address for the 1505A card:*

1. **Open the Device Manager window.** Double-click the System icon located in the Control Panel program group. The System Properties window is displayed. Click the Device Manager tab to display the Device Manager window.
2. **Determine what IRQs and I/O addresses are in use by installed add-in card(s).** Double-click the Computer icon. The Computer Properties window is displayed. Choose the Interrupt request (IRQ) radio button to view the IRQs already in use. Choose

the Input/output (I/O) radio button to view the I/O addresses already in use.

- 3. Set the IRQ and I/O address for the 1505A card.** The default interrupt number is IRQ11, but can be set from IRQ9 to IRQ12. The default I/O address is 340h-35Fh, but can be set to 140h-15Fh. Refer to the “Jumper Block Settings” section in the *Adaptec AVA-1505A AT-to-SCSI Host Adapter Installation Guide* for information about changing the I/O address on the 1505A card.

If all the interrupts between IRQ9 and IRQ12 are being used, you must change the IRQ settings on another card to free up one of these interrupts for the 1505A card.

### ***Install the SCSI Board Into your PC***

Turn off your computer, remove its cover, and install the 1505A card into an ISA expansion slot in the PC. After installing the card, replace the cover and turn the PC on. Refer to the “Inserting the Board” section in the *Adaptec AVA-1505A AT-to-SCSI Host Adapter Installation Guide* for additional information about installing the 1505A card.

### ***Run the Add New Hardware Wizard***

Windows 95 comes with an Add New Hardware wizard that detects new add-in cards and drivers. This wizard automatically assigns an IRQ and I/O address to the new card. These settings may not match the card’s actual configuration. If the settings on the card do not match the settings in the wizard, you must change the settings in the wizard or on the 1505A card.

**Note:** The settings that are selected in the Add New Hardware wizard must match the actual settings on the 1505A card, your BIOS, and the settings in your config.sys. file. Refer to “Configure the Software Driver” on page 10 for information about configuring your software driver.

*To run the Add New Hardware wizard:*

- 1. Invoke the Add New Hardware wizard.** Double-click the Add New Hardware icon located in the Control Panel group. The Add New Hardware wizard is displayed.

- 2. Follow the instructions on the screen.** Select “No” when asked if you want Windows to search for your new hardware and “SCSI controllers” when asked for the type of hardware you want to install. Choose “Adaptec” and “AIC 6 x 60 ISA SCSI Controller” when asked to select Manufacturer and Model for your hardware.
- 3. Note the IRQ and I/O address.** If the IRQ and I/O address match the settings you selected for the card, click the Next button. If the settings do not match, then change the software settings to match the 1505A card settings (see “Configure the Software Driver” in the following section) or change the card settings to match the software settings (see “Select a Unique IRQ and I/O Address” on page 8).

### **Configure the Software Driver**

Actel uses the driver installed by Windows 95 when you add the 1505A card using the Add New Hardware wizard. If the settings on your 1505A card match the setting assigned to the card by the wizard, you do not need to configure the software driver. If the settings do not match, use the following procedure to configure the software driver.

- 1. Open the Device Manager window.** Double-click the System icon located in the Control Panel program group. The System Properties window is displayed. Click the Device Manager tab to display the Device Manager window.
- 2. Open the 1505A card Properties window.** Double-click the SCSI controllers icon. Double-click the 1505A card icon (it may show up as the “Adaptec 1505A SCSI Adapter” driver, the “Adaptec AIC-6260/6360” driver, or as the “ISA SCSI” driver). The SCSI Controller Properties window is displayed.
- 3. Change the I/O address settings.** Click the Resources tab. Make sure the Use automatic settings box is not checked. Choose Input/Output Range in the Resource settings window and click the Change Settings button. Change the I/O address to match the settings you selected on the 1505A card. Click OK.
- 4. Change the IRQ settings.** Choose Interrupt Request in the Resource settings window and click the Change Settings button. Change the IRQ to match the settings you selected on the 1505A card. Click OK.



*To verify that the software driver is configured properly:*

- 1. Open the Device Manager window.** Double-click the System icon located in the Control Panel program group. The System Properties window is displayed. Click the Device Manager tab to display the Device Manager window.
- 2. View the 1505A card properties.** Double-click the SCSI controllers icon. The 1505A card icon is displayed (it may show up as the “Adaptec 1505A SCSI Adapter” device, the “Adaptec AIC-6260/6360” device, or as the “ISA SCSI” device). If there is a yellow dot with an exclamation point next to the name, then you have a hardware conflict.

Review the IRQs and I/O addresses used by the other add-in cards to determine where the conflict is occurring. If you change the 1505A card settings, remember to change the BIOS and software settings to match, as described in the preceding sections. After each change, check the Device Manager again until you resolve the conflict.

### ***Configure the Termination Resistors***

If an Activator is sharing a 1505A card with other SCSI devices, the devices must be terminated properly. Refer to the “Terminating the SCSI Bus Cable” section in the *Adaptec AVA-1505A AT-to-SCSI Host Adapter Installation Guide* for information about terminating SCSI devices.

If you do not have other SCSI devices connected to the 1505A card, the termination resistors do not need to be changed.

### ***Connect the Activator to the 1505A Card***

Once you have installed the 1505A card, you must connect the Activator to your PC through the 1505A card. Go to “Connecting an Adaptec SCSI Card to the Activator” on page 14 for the procedure.

## ***Installing the 1505A Card Under Windows NT***

This section describes how to install the 1505A card under Windows NT.

### **Select a Unique IRQ and I/O Address**

The default settings on the 1505A card should work. However, you may have an add-in card installed on your PC with IRQ and I/O address settings that conflict with the default settings on the 1505A card. The conflict may affect your video, network connection, or hard drive. If there is a conflict, you must change the IRQ and I/O address of either the 1505A card or an installed add-in card.

*To select the IRQ and I/O address for the 1505A card:*

- 1. Open the Windows NT Diagnostics Window.** Choose Windows NT Diagnostics from the Administrative Tools (Common) menu in the Programs menu.
- 2. Determine what I/O addresses are in use by installed add-in card(s).** Click the Resources tab. The Resources window is displayed. Click the IRQ button to display the interrupts being used. Click the I/O Port button to display the addresses being used.
- 3. Set the I/O address for the 1505A card.** The default I/O address is 340h-35Fh, but can be set to 140h-15Fh. Refer to the “Jumper Block Settings” section in the *Adaptec AVA-1505A AT-to-SCSI Host Adapter Installation Guide* for information about changing the I/O address on the 1505A card.

If all the interrupts between IRQ9 and IRQ12 are being used, you must change the IRQ settings on another card to free up one of these interrupts for the 1505A card.

### **Install the SCSI Board Into your PC**

Turn off your computer, remove its cover, and install the 1505A card into an ISA expansion slot in the PC. After installing the card, replace the cover and turn the PC on. Refer to the “Inserting the Board” section in the *Adaptec AVA-1505A AT-to-SCSI Host Adapter Installation Guide* for additional information about installing the 1505A card.

### **Install the Windows NT Driver**

After installing and configuring the 1505A card, you must install two drivers under Windows NT. The first driver is provided by Microsoft. The second driver is provided by Actel. Go to “Install the Software Driver” on page 13 for installation instructions for the Actel driver.

*To install the Windows NT driver:*

- 1. Open the Add SCSI Adapters window.** Double-click the SCSI Adapters icon located in the Control Panel program group.
- 2. Add the 1505A card driver.** Click the Drivers tab. The Drivers window is displayed. Choose “Adaptec AIC-6X60 ISA Single-Chip SCSI Controller” from the list of devices. Put the Windows NT 4.0 CD-ROM into the drive and Click OK. The NT driver is installed.
- 3. Re-boot the PC.** You must re-boot for this driver to take effect.

*To verify that the Windows NT driver is installed correctly:*

- 1. Open the Add SCSI Adapters window.** Double-click the SCSI Adapters icon located in the Control Panel program group.
- 2. View the 1505A care properties.** Click the Drivers tab. The Drivers window is displayed. Look for the “Adaptec AIC-6X60 ISA Single-Chip SCSI Controller” driver. Its status should be “Started.”

If there is a yellow dot with an exclamation point next to the driver name, then you have a hardware conflict. Review the IRQs and I/O addresses used by the other add-in cards to determine where the conflict is occurring. If you change the 1505A card settings, remember to change the BIOS and software settings to match, as described in the preceding sections. After each change, check the Device Manager again until you resolve the conflict.

## ***Install the Software Driver***

In addition to the Windows NT driver, you must install the Adaptec ASPI driver provided by Actel.

*To install the Adaptec ASPI driver:*

Insert the Designer Series CD-ROM into the drive and execute the following program on the CD-ROM:

```
\ASPI_NT\ASPIINST.EXE
```

After installation your computer will re-boot.

*To verify that the software driver is configured properly:*

Double-click the Devices icon located in the Control Panel program group. Look for the “Aspi32” driver. Its status should be “Started” and “Automatic.”

### **Configure the Termination Resistors**

If an Activator is sharing a 1505A card with other SCSI devices, the devices must be terminated properly. Refer to the “Terminating the SCSI Bus Cable” section in the *Adaptec AVA-1505A AT-to-SCSI Host Adapter Installation Guide* for information about terminating SCSI devices.

If you do not have other SCSI devices connected to the 1505A card, the termination resistors do not need to be changed.

### **Connect the Activator to the 1505A Card**

Once you have installed the 1505A card, you must connect the Activator to your PC through the 1505A card, as described on page 14.

## **Connecting an Adaptec SCSI Card to the Activator**

You can only use an Adaptec SCSI card with an Activator 2 or 2s. If you have an existing Adaptec SCSI card installed, you can use it instead of the 1505A card to interface with an Activator.

*To connect a SCSI card to an Activator:*

Connect the SCSI card to the Activator using the appropriate SCSI cable for the board’s external SCSI connector and the Activator 2 or 2s connector (female DB50 for Activator 2, DB25 for Activator 2s).

### **IMPORTANT:**

Activators contain termination resistors and must be the last device in the SCSI chain.

If SCSI ID number 5 is not available on your SCSI bus, set the rotary switch on the back of your Activator to an available SCSI ID, and modify the “Windows Programming” icon in the Designer Series Program Group using the following procedure:

1. **Open the Designer Series program group.** Right-click the Start button and select the Open All Users command (Open command for Windows 95). Double-click the Programs icon. Double-click the Designer Series icon.
2. **Modify the Windows Programming icon.** Click the Windows Programming icon. Choose the Properties command from the File menu. Click the Shortcut tab. Type the following in the Target box:

```
c:\actel\bin\apsw.exe devactivator2:4
```

The “4” represents the SCSI ID you want to set the Activator to use.

## *Installing the Activator*

The following procedure describes how to install an Activator 2 or 2s on a PC:

1. **Turn off the PC.**
2. **Verify that the Activator power switch is OFF.** See Figure 1-1 on page 2 or Figure 1-2 on page 3 for the location of the power switches.
3. **Verify that the SCSI rotary switch is set to an available ID.** The location of this switch is shown in Figure 1-1 on page 2 or Figure 1-2 on page 3. The default ID is 5. refer to “Connecting an Adaptec SCSI Card to the Activator” on page 14 for information about changing the SCSI ID.
4. **Connect the Activator to the PC using the supplied cable.** Connect one end of the cable to the SCSI connector on the Activator rear panel (you can use either connector on the Activator 2) and tighten the locking screws. Connect the other end of the cable to the 1505A card in the PC and tighten the locking screws. The Activator is terminated internally and must be the last device on the SCSI chain. See Figure 2-1 for the location of the SCSI connectors.

### **CAUTION:**

The SCSI connector on the 1505A card is a female DB25 that can be confused with a parallel port connector. Make sure you plug the cable into the 1505A card or you could damage the connectors.

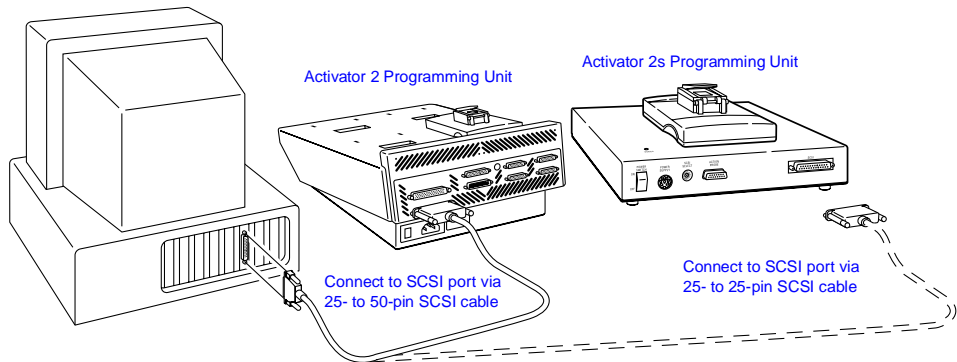

Figure 2-1. Activator 2 and 2s PC Connections

**5. Connect power to the Activator.**

**Activator 2**

Insert the power cord into the power connector located on the rear panel and plug the other end into an AC power outlet.

**Activator 2s**

Insert the 8-pin DIN connector from the power supply into the DIN power jack located on the rear panel. Connect an AC power cord to the power supply and plug the other end into an AC power outlet (Figure 2-2).

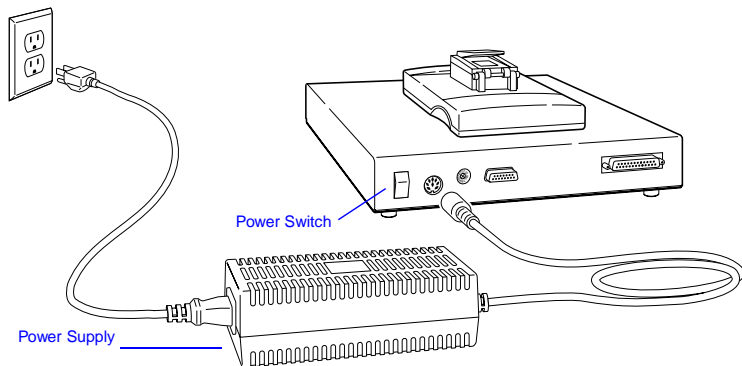

Figure 2-2. Power Supply Connected to Activator 2s

**Note:** The power supplies are rated for 100–240 VAC at 50 or 60 Hz. The Activator 2s power switch will remotely power down the power supply. Only a small voltage will remain to detect power up.

- 6. Turn on the Activator power.** After a brief delay, the green power light should turn on and remain on continuously as long as the power is turned on.
- 7. Turn on the PC.** You are now ready to program a device using APSW. Refer to chapter 4, “Programming an Actel Device” on page 27 for information about programming a device.

### **Verifying Hardware Installation (NT 4.0)**

Use the following procedure to verify that the Activator installed correctly:

- 1. Open the Devices window.** Double-click the SCSI Adapters icon located in the Control Panel program group. The SCSI Adapters window is displayed. Click the Devices tab to display the Devices window.
- 2. View the 1505A card.** Double click the “Adaptec AIC-6X60 ISA Single-Chip SCSI Controller” device driver. If eight unnamed tape drive icons appear, the Activator hardware installation was successful. If the icons do not appear, make sure the SCSI cable connection are correct, all cable connections are seated together firmly, and the power is connected properly and is turned on. Also make sure the SCSI ID rotary switch on the Activator is set to an available ID and matches what is set in the Windows Programming icon.

## *Installing and Removing an Adapter Module*

The following procedure describes how to install an Adapter Module into and remove an Adapter Module from an Activator.

*To install an Adapter Module:*

- 1. Position the two metal guides on the Adapter Module into the corresponding slots on the Activator.**
- 2. Press down on the Adapter Module to seat the connector firmly on the bottom of the module.** Do not force the Adapter Module, it should fit easily. Be sure to keep the connector area clean.

*To remove an Adapter Module:*

- 1. Pull the top of the Adapter Module toward you until the connector comes free.** Indentations are provided on the Adapter Module to facilitate this step.
- 2. Slide the Adapter Module upward to free the two metal guides.**



---

## Hardware Installation on a Workstation

This chapter contains information and procedures to install an Activator 2 or 2s on a workstation running SunOS, Solaris, or HP-UX. This includes information about creating a link to an Activator.

### Installing an Activator on a SunOS Workstation

The following procedure describes how to install an Activator 2 or 2s on a SunOS workstation:

1. **Shutdown, then power down the workstation.** When shutting the system down, turn off power to the workstation before turning off power to the Activator.

#### **WARNING:**

Do not connect SCSI cables to the Activator while the workstation or other peripherals are turned on; data loss may result.

2. **Verify that the Activator is OFF.** See Figure 1-1 on page 2 or Figure 1-2 on page 3 for the location of the power switches.
3. **Set the position of the SCSI rotary switch.** The location of this switch is shown in Figure 1-1 on page 2 or Figure 1-2 on page 3. If you want to map the Activator to “rst1,” set the rotary switch to position 5. If you want to map the Activator to device “rst0,” set the rotary switch to position 4.
4. **Connect the Activator to the workstation using the supplied SCSI cable.** Connect one end of the cable to a SCSI connector on the Activator rear panel (you can use either connector on the Activator 2) and tighten the locking screws. Connect the other end of the cable to the SCSI connector of the workstation and tighten the locking screws or make sure the micro-miniature SCSI connector has snapped into place. See Figure 3-1 on page 20 for the location of the SCSI connectors.

The Activator is terminated internally. If several devices are daisy-chained to the SCSI port, it must be the last device in the chain.

**Note:** Daisy chaining may require a cable with a different type of connector. The Activator SCSI cable is a standard cable with no scrambling. However, other connector combinations can be purchased. The cable length must not exceed 6 feet.

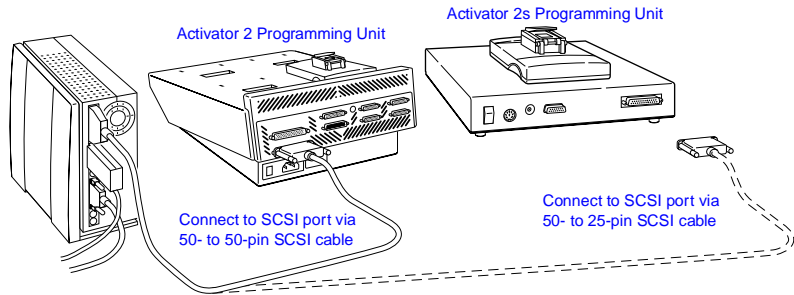

Figure 3-1. Activator 2 and 2s Workstation Connections

**5. Connect power to the Activator.**

**Activator 2**

Insert the power cord into the power connector located on the rear panel and plug the other end into an AC power outlet.

**Activator 2s**

Insert the 8-pin DIN connector from the power supply into the DIN power jack located on the rear panel. Connect an AC power cord to the power supply and plug the other end into an AC power outlet (see Figure 2-2 on page 16).

**Note:** The power supplies are rated for 100–240 VAC at 50 or 60 Hz. The Activator 2s power switch will remotely power down the power supply. Only a small voltage will remain to detect power up.

**6. Turn on the Activator power.** After a brief delay, the green power light should turn on and remain on continuously as long as the power is on.

**7. Power up the Workstation.**

You must create a link to the Activator to complete installation. Go to “Creating a Link to the Activator” on page 21 for the procedure.

## ***Creating a Link to the Activator***

Once you have installed the Activator on the workstation, you must create a symbolic link to the Activator to complete installation. Use the following procedure to create a symbolic link:

- 1. Log in as ROOT.**
- 2. Create a symbolic link to the Activator.** To map the Activator to “rst1,” verify that the Activator SCSI rotary switch is set to position 5 and type the following command at the prompt:

```
ln -s /dev/rst1 /dev/activator2
```

**Note:** Because “rst0” is usually used for a tape drive or another storage unit, the Activator SCSI rotary switch is by default set to position 5 for use with “rst1.”

To map the Activator to “rst0,” verify that the Activator SCSI rotary switch is set to position 4 and type the following command at the prompt:

```
ln -s /dev/rst0 /dev/activator2
```

You are now ready to program a device using APSW. Refer to chapter 4, “Programming an Actel Device” on page 27 for information about programming a device.

## *Installing an Activator on a Solaris Workstation*

The following procedure describes how to install an Activator 2 or 2s on a Solaris workstation:

- 1. Shutdown, then power down the workstation.** When shutting the system down, turn off power to the workstation before turning off power to the Activator.

### ***WARNING:***

Do not connect SCSI cables to the Activator while the workstation or other peripherals are turned on; data loss may result.

- 2. Verify that the Activator is OFF.** See Figure 1-1 on page 2 or Figure 1-2 on page 3 for the location of the power switches.

3. **Set the position of the SCSI rotary switch.** The location of this switch is shown in Figure 1-1 on page 2 or Figure 1-2 on page 3. The switch is set to position 5 by default, but it must be set to another position. Actel recommends setting it to position 3 or 4. The switch settings correspond to device files, which may require a system administrator to create.
4. **Connect the Activator to the workstation using the supplied SCSI cable.** Connect one end of the cable to a SCSI connector on the Activator rear panel (you can use either connector on the Activator 2) and tighten the locking screws. Connect the other end of the cable to the SCSI connector of the workstation and tighten the locking screws or make sure the micro-miniature SCSI connector has snapped into place. See Figure 3-1 on page 20 for the location of the SCSI connectors.

The Activator is terminated internally. If several devices are daisy-chained to the SCSI port, it must be the last device in the chain.

**Note:** Daisy chaining may require a cable with a different type of connector. The Activator SCSI cable is a standard cable with no scrambling. However, other connector combinations can be purchased. The cable length must not exceed 6 feet.

5. **Connect power to the Activator.**

#### **Activator 2**

Insert the power cord into the power connector located on the rear panel and plug the other end into an AC power outlet.

#### **Activator 2s**

Insert the 8-pin DIN connector from the power supply into the DIN power jack located on the rear panel. Connect an AC power cord to the power supply and plug the other end into an AC power outlet (see Figure 2-2 on page 16).

**Note:** The power supplies are rated for 100–240 VAC at 50 or 60 Hz. The Activator 2s power switch will remotely power down the power supply. Only a small voltage will remain to detect power up.

- 6. Turn on the Activator power.** After a brief delay, the green power light should turn on and remain on continuously as long as the power is on.
- 7. Power up the workstation.**
- 8. Interrupt the boot sequence.** On a Type 4 keyboard, press the “L1” and “A” keys simultaneously. On a type 5 keyboard, press the “Stop” and “A” keys simultaneously.
- 9. Initiate a reconfiguration boot.** Type “boot -r” at the ok prompt.
- 10. Verify that the Activator driver is installed.** After the system boots, check the “/dev/rmt” directory. You should see multiple tape devices called “0mn,” “0m,” etc.
- 11. Create a link to the Activator.**

You must create a link to the Activator to complete installation. Go to “Creating a Link to the Activator” below for the procedure.

### ***Creating a Link to the Activator***

Once you have installed the Activator on the workstation, you must create a symbolic link to the Activator to complete installation. Use the following procedure to create a symbolic link:

- 1. Log in as ROOT.**
- 2. Create a symbolic link to the Activator.** Type the following command at the prompt:

```
ln -s <device_file> /dev/activator2
```

For example, if you have set the SCSI rotary switch to position 3, verify the device file “/dev/rmt/3mn” exists, then create a symbolic link as follows:

```
ln -s /dev/rmt/3mn /dev/activator2
```

If “/dev/rmt/3mn” does not exist, or if you don’t know which SCSI ID to set the rotary switch to, contact your system administrator for help.

You are now ready to program a device using APSW. Refer to chapter 4, “Programming an Actel Device” on page 27 for information about programming a device.

## Installing an Activator on an HP-UX Workstation

The following procedure describes how to install an Activator 2 or 2s on an HP-UX workstation:

1. **Shutdown, then power down the workstation.** When shutting the system down, turn off power to the workstation before turning off power to the Activator.

### **WARNING:**

Do not connect SCSI cables to the Activator while the workstation or other peripherals are turned on; data loss may result.

2. **Verify that the Activator is OFF.** See Figure 1-1 on page 2 or Figure 1-2 on page 3 for the location of the power switches.
3. **Set the position of the SCSI rotary switch.** The location of this switch is shown in Figure 1-1 on page 2 or Figure 1-2 on page 3. The switch is set to position 5 by default, but it must be set to another position. Actel recommends setting it to position 3 or 4. The switch settings correspond to device files, which may require a system administrator to create.
4. **Connect the Activator to the workstation using the supplied SCSI cable.** Connect one end of the cable to a SCSI connector on the Activator rear panel (you can use either connector on the Activator 2) and tighten the locking screws. Connect the other end of the cable to the SCSI connector of the workstation and tighten the locking screws or make sure the micro-miniature SCSI connector has snapped into place. See Figure 3-1 on page 20 for the location of the SCSI connectors.

The Activator is terminated internally. If several devices are daisy-chained to the SCSI port, it must be the last device in the chain.

**Note:** Daisy chaining may require a cable with a different type of connector. The Activator SCSI cable is a standard cable with no scrambling. However, other connector combinations can be purchased. The cable length must not exceed 6 feet.

**5. Connect power to the Activator.**

**Activator 2**

Insert the power cord into the power connector located on the rear panel and plug the other end into an AC power outlet.

**Activator 2s**

Insert the 8-pin DIN connector from the power supply into the DIN power jack located on the rear panel. Connect an AC power cord to the power supply and plug the other end into an AC power outlet (see Figure 2-2 on page 16).

**Note:** The power supplies are rated for 100–240 VAC at 50 or 60 Hz. The Activator 2s power switch will remotely power down the power supply. Only a small voltage will remain to detect power up.

**6. Turn on the Activator power.** After a brief delay, the green power light should turn on and remain on continuously as long as the power is on.

**7. Power up the workstation.**

You must create a link to the Activator to complete installation. Go to “Creating a Link to the Activator” below for the procedure.

***Creating a Link to the Activator***

Once you have installed the Activator on the workstation, you must create a symbolic link to the Activator to complete installation. Use the following procedure to create a symbolic link:

**1. Log in as ROOT.**

**2. Create a symbolic link to the Activator.** Type the following command at the prompt:

```
ln -s <device_file> /dev/activator2
```

For example, if you have set the SCSI rotary switch to position 3, verify the device file “/dev/rmt/3mn” exists, then create a symbolic link as follows:

```
ln -s /dev/rmt/3mn /dev/activator2
```

If “/dev/rmt/3mn” does not exist, or if you don’t know which SCSI ID to set the rotary switch to, contact your system administrator for help.

You are now ready to program a device using APSW. Refer to chapter 4, “Programming an Actel Device” on page 27 for information about programming a device.

## *Installing and Removing an Adapter Module*

The following procedure describes how to install an Adapter Module into and remove an Adapter Module from an Activator.

### *To install an Adapter Module:*

- 1. Position the two metal guides on the Adapter Module into the corresponding slots on the Activator programmer.**
- 2. Press down on the Adapter Module to seat the connector firmly on the bottom of the module.** Do not force the Adapter Module, it should fit easily. Be sure to keep the connector area clean.

### *To remove an Adapter Module:*

- 1. Pull the top of the Adapter Module toward you until the connector comes free.** Indentations are provided on the Adapter Module to facilitate this step.
- 2. Slide the Adapter Module upward to free the two metal guides.**



---

# Programming an Actel Device

This chapter discusses the recommended programming flow and describes the procedure for programming an Actel device using an Activator connected to a PC or workstation and the APSW programming software.

## Programming Flow

The recommended programming flow for an Actel device has two steps: program a device, and save the AVI file. These steps are described in the following sections.

### ***Program a Device***

Use an Activator to program your device. Make sure you follow ESD device handling procedures when removing a device from its packaging and when placing it into an Activator. Refer to “Device Handling” on page 1 and “Removing a Device from the Carrying Case” on page 32 for information about handling and unpacking Actel devices.

### ***Save the AVI File***

Once you have programmed your device, save your AVI file. When you program a chip, the programming history is saved in the <design\_name>.avi file. The AVI file contains programming data for each antifuse programmed, including the number of programming pulses applied and fuse current readings. This file is overwritten each time you select the Activate command. Refer to Appendix C, “AVI File Description” on page 63 for information about the AVI file.

If your device fails to program, refer to Chapter 5, “Device Programming Failure Guidelines” on page 41 for information about programming failures and maximum allowed programming failure guidelines.

## APSW Description

This section describes the APSW interface including information about using the interface to program Actel devices. Figure 4-1 shows the main window for APSW.

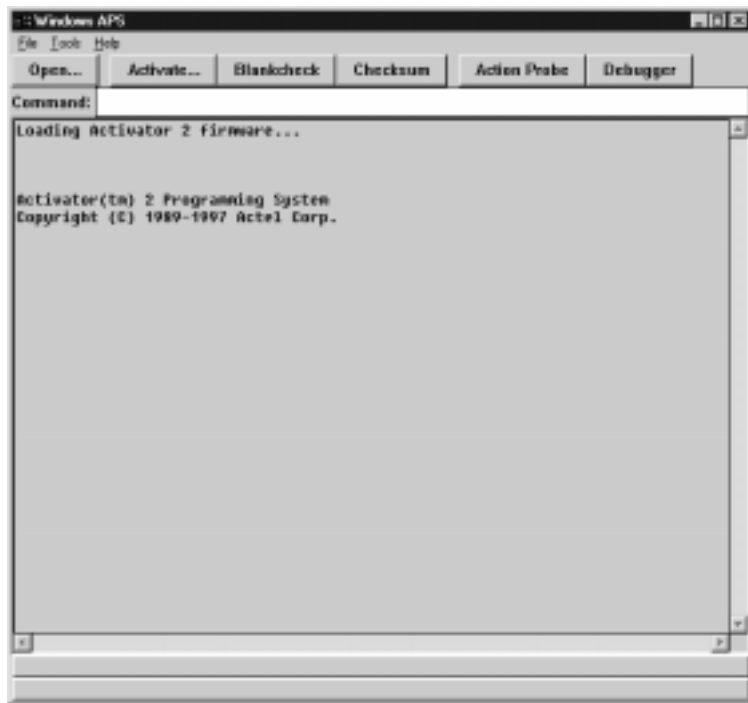

Figure 4-1. APSW Main Window

### Open

The Open button or menu command opens a programming file.

*To open a programming file:*

Click the Open button or choose the Open command from the File menu. The Open dialog box is displayed. Type in the design name or browse to the directory that contains the <design\_name>.adb (or .afm) file and select it. Click OK.

## **Activate**

The Activate button or menu command is used to program a device. Refer to “Programming a Device” on page 33 for detailed information about using the Activate command to program an Actel device.

## **Blankcheck**

The Blankcheck button or menu command executes a test to determine if a device has already been programmed. Blankcheck displays a report for each Activator socket that has an adapter module plugged into it (the Activator 2S only has one socket). Blankcheck is performed automatically before the chip is programmed whenever the Activate command is used.

The result of executing Blankcheck is either “blank” or “not blank” followed by the Silicon Signature, Checksum, and Security Fuse status read from the device. Only blank devices of the correct type (according to the design parameters) result in a blank status. A Security Fuse status of 0 indicates that the security fuse has not been programmed; a 1 indicates that the security fuse has been programmed.

### *To run Blankcheck:*

Click the Blankcheck button, or choose the Blankcheck command from the Tools menu.

## **Checksum**

The Checksum button or menu command verifies that the current programming file is the same one that was used to program the device. The Checksum command compares the checksum number, computed from the programming file, to the checksum number programmed into the chip. If the two numbers are the same, APSW displays “PASSED.” If the two numbers are not the same, the program displays “FAILED,” with additional comments to briefly explain why it failed.

**Note:** If you have already programmed the Probe fuse on an ACT 1 device, you cannot read the Checksum from the device.

### *To run Checksum:*

Click the Checksum button, or choose the Checksum command from the Tools menu. The checksum number is displayed in the APSW window, along with a “Passed” or “Failed” message. If Checksum fails, a message is displayed that describes why it failed.

### **Action Probe**

The Action Probe button or menu command initializes the Action Probe software and opens the Explore window for verifying a programmed device using the Actel Silicon Explorer diagnostic tool. The Silicon Explorer allow you to probe the internal signals of the device while it operates in your system. Refer to Chapter 7, “Silicon Explorer Diagnostic Tool” on page 57 for information.

#### *To run Action Probe:*

Click the Action Probe button, or choose the Action Probe command from the Tools menu.

**Note:** If you have already programmed the Probe fuse on an ACT 1 or 40MX device or the Security fuse on any other Actel device, you cannot use the Action Probe software to verify the device.

### **Debugger**

The Debugger button or menu command initializes the Debugger test environment. The Debugger environment allows you to test a programmed device before you place it in your system circuit. With Debugger, you can probe the chips internal nodes by applying stimulus through an Activator. Debugger commands are entered through the Command box located at the top of the APSW window. If the Action Probe software has already been initialized, Debugger is also initialized and available for use. When you use Debugger with an Activator 2s, APSW recognizes the Adapter Module as port 4. Refer to Chapter 7, “Verifying a Device with an Activator” on page 43 for information about using Debugger.

#### *To run Debugger:*

Click the Debugger button, or choose the Debugger command from the Tools menu.

**Note:** If you have already programmed the Probe fuse on an ACT 1 or 40MX device or the Security fuse on any other Actel device, you cannot use the Action Probe software to verify the device.

**Command Box** The Command box is used to enter Debugger command-line commands. Refer to “Debugger Command-Line Commands” on page 45 for information.

## Programming a Device with APSW

This section contains information about programming files and describes the procedure for programming an Actel device with APSW.

### Supported Device Files

To program devices with APSW, you must have an Actel programming file. APSW can read the following programming file types:

- Actel database file (ADB) for a design that has a completed layout
- Actel programming file (AFM) exported from Designer using the Fuse command
- FUS and DEF files produced from pre-Designer 3.0 software

**Note:** If Layout has been completed in Designer, you do not need to execute the Fuse command. APSW automatically extracts programming information from the ADB file.

### User-Defined Silicon Signature

To specify a user-defined Silicon Signature to be programmed into a device, enter the signature from within Designer using one of the following methods:

- 1. Create an AFM file containing a Silicon Signature.** Select the Fuse command, enter the Silicon Signature, then export the .afm file. Refer to the *Design with Actel* manual for information about how to use the Fuse command to generate an AFM file.
- 2. Set the SIG variable.** Choose Set from the Options menu, and enter the desired value.

**Note:** The Silicon Signature must be a hexadecimal number, no more than 5 digits long.

### **Removing a Device from the Carrying Case**

Use the following ESD procedure to remove an Actel device from the insulative individual carrying case before placing it in an Adapter Module.

#### **IMPORTANT:**

You should always wear a grounded wrist strap at an ESD workstation when handling Actel devices. A calibrated ionizer should be on and functioning properly at the workstation. An ionizer air stream should be directed over the devices at all times.

- 1. Slowly remove the individual carrying case from the carrier box.** The individual carrying case may build a charge while being removed from the foam in the carrier box.
- 2. Ionize the individual carrying case.** Hold the individual carrying case approximately three feet from the ionizer. Expose each side of the case to the air stream for 30 to 60 seconds.
- 3. Remove the device from the individual carrying case.** Open the case, remove the device and place the device on top of ESD sensitive foam.

The device can now be placed in the Adapter Module or repackaged in a static dissipative container.

### **Programming Checklist**

Before executing any commands in APSW, verify the following:

1. The Activator is powered on and the green LED is lit.
2. The appropriate Adapter Module(s) is plugged into the socket(s) on the Activator.
3. A device is inserted in the Adapter Module, with pin 1 oriented as indicated in the diagram printed on the Adapter Module.

**Note:** Insert a device into the Adapter Module socket after the Module is plugged in and the Activator is powered up.

## Programming a Device

Programming typically requires from 5 to 15 minutes for commercial and RadTolerant devices and 30 to 60 minutes for RadHard devices, depending on design complexity, the Actel device you have chosen, and your system environment. During programming, the Activator dynamically verifies that each antifuse is programmed correctly. In addition, test vectors are applied to verify that only the selected antifuses are programmed. Due to the unique, high-density architecture of Actel devices, you can verify the programmed state of all antifuses only during programming, not after. The following procedure describes how to program a device.

### 1. Invoke APSW.

#### Workstation

Type the following command at the prompt:

```
apsw
```

#### PC

Double click the “Windows Programming” icon located in the Designer Series program group.

The APSW window is displayed (see Figure 4-1).

- 2. Open your design.** Click the Open button or choose the Open command from the File menu. The Open dialog box is displayed. Type in the design name or browse to the directory that contains the <design\_name>.adb (or .afm) file and select it. Click OK.
- 3. Choose fuse programming options.** Click the Activate button or choose the Activate command from the Tools menu. The Activate Options dialog box is displayed.
- 4. Program your device.** You can program Array fuses only, the Security fuse(s) only, or both Array fuses and the Security fuse(s). For ACT 1 and 40MX devices, the dialog box shown in Figure 4-2 is displayed. For all other devices, the dialog box shown in Figure 4-3 is displayed. Choose the desired fuse programming options and click OK. Refer to “Programming Security Fuses” on page 34 for a discussion about programming security fuses.

**IMPORTANT:**

The Program or Security fuse must be the last fuse programmed.

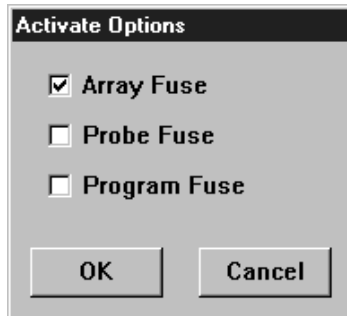

Figure 4-2. Activate Options for ACT1 and 40MX Devices



Figure 4-3. Activate Options for all Other Devices

An Output Window is displayed on the screen and the programming sequence begins. The status bar in the Output Window displays the percentage complete of the programming sequence. When the device is 100% programmed, the finished programming status “Passed” or “Failed” is displayed in the window.

5. **Save the AVI file.** Exit APSW and move or rename the AVI file for the design. The AVI file is written to the same directory as your programming file. Refer to Appendix C, “AVI File Description” on page 63 for information about AVI files.

## Programming Security Fuses

You can program the Security fuse(s) on an Actel device that has had its Array fuses previously programmed. The ability to program the Security fuse(s) after programming Array fuses is designed to allow you to verify your device design with the Debugger or Silicon Explorer diagnostic tool. After you verify your design, you can program the Security fuses to secure the device from further probing.



## ACT 1 and 40MX Security Fuse Configurations

The ACT 1 devices contain two security fuses: Probe and Program. Programming the Probe fuse disables the Probe Circuitry, which disables the use of the Debugger and Silicon Explorer diagnostic tools. Programming the Program fuse prevents further programming of the device, including programming the Probe fuse. Table 4-1 summarizes the effects of programming the Security fuses on the PRA, PRB, SDI, and DCLK pins.

Table 4-1. ACT 1 and 40MX Security Fuse Configurations

Mode <sup>1</sup>	Program	Probe	PRA, PRB	SDI, DCLK
low	no	no	user-defined I/O	user-defined input <sup>2</sup>
low	no	yes <sup>3</sup>	user-defined I/O	user-defined input <sup>2</sup>
low	yes <sup>4</sup>	no	user-defined I/O	user-defined I/O
low	yes <sup>4</sup>	yes <sup>3</sup>	user-defined I/O	user-defined I/O
high	no	no	Probe Circuit outputs <sup>5</sup>	Probe Circuit inputs <sup>6</sup>
high	no	yes <sup>3</sup>	Probe Circuit disabled	Probe Circuit disabled
high	yes <sup>4</sup>	no	Probe Circuit outputs <sup>5</sup>	Probe Circuit inputs <sup>6</sup>
high	yes <sup>4</sup>	yes <sup>3</sup>	Probe Circuit disabled	Probe Circuit disabled

In the normal operating mode (MODE=0), all undefined device pins in a design are automatically configured as active LOW outputs.

Two exceptions are the SDI and DCLK pins. If the Program fuse is not programmed and SDI and DCLK are undefined, they are configured as inactive inputs. In this case, SDI and DCLK pins should be tied to

ground. If the Program fuse is programmed and SDI and DCLK are undefined, they will become active LOW outputs.

**Legend for Table 4-1**

1. The MODE pin switches the device between the normal operating mode (MODE=0) and the Probe Circuit mode (MODE=1).
2. The Program fuse must be programmed if the SDI or DCLK pins are to be used as an output or a bi-directional pin.
3. If the Probe fuse is programmed, the Probe Circuit is permanently disabled, which disables the Debugger and Silicon Explorer diagnostic tools.
4. If the Program fuse is programmed, all programming of the device is disabled, including programming the array fuses and the Probe fuse.
5. The PRA output and a separate I/O buffer share the use of a single device pin. The PRA output and the output function of the I/O buffer are multiplexed. The same is true for PRB. The Probe Mode that is loaded into the Mode Register will determine which output buffer is active during probing. There are three possible Probe Modes: "PRA only," "PRB only," and "PRA and PRB."

When the "PRA only" mode is selected, the PRA output becomes active and the output function of the I/O buffer associated with the PRA pin is inhibited. However, the input buffer portion of the I/O buffer associated with the PRA pin is still active. Any internal signal that appears on the PRA output is fed back through that input buffer to the internal Logic Modules. This could interfere with the expected function of the design during probing. Actel recommends that you use an input latch on PRA and PRB to prevent the feedback while probing. PRB will function as a normal I/O in the "PRA only" mode.

The "PRB only" mode is functionally equivalent to the "PRA only" mode. PRA also functions as a normal user I/O in the "PRB only" mode.

When the "PRA and PRB" mode is selected, both the PRA and PRB outputs become active and the output function of the I/O buffers associated with both pins are inhibited. However, the input buffer

of the I/O buffers associated with both pins are still active. Any internal signals that appear on the PRA and PRB outputs are fed back through the input buffers to the internal Logic Modules. This could interfere with the expected function of the design while probing. Actel recommends that you use an input latch on PRA and PRB to prevent the feedback during probing.

6. The SDI input and a separate I/O buffer share the use of a single device pin. The SDI input and the input function of the I/O buffer are connected in parallel. When the Mode pin is high, both inputs are active. The same is true for DCLK. External Probe Circuit control signals sent to those pins are also sent to the internal Logic Modules. This could interfere with the expected function of the design while probing. Actel recommends that you use an input latch on SDI and DCLK to prevent the external Probe Circuit control signals from effecting the functionality of your design during probing.

If either SDI or DCLK are configured so that the output function of the I/O buffer is active, the Program fuse must be programmed. In this configuration, the signals from your design are fed back to the Shift Register and will interfere with the function of the Probe Circuitry. In addition, the I/O drivers will conflict the external SDI and DCLK drivers. Damage to both drivers could occur.

### Non-ACT 1/ 40MX Security Fuse Configurations

All Actel devices other than ACT 1 and 40MX devices contain one Security fuse. Programming the Security fuse disables the Probe Circuitry, which disables the use of the Debugger and Silicon Explorer diagnostic tools. Table 4-2 summarizes the effect of programming the security fuse on the PRA, PRB, SDI, and DCLK pins.

Table 4-2. Non ACT 1/40MX Security Fuse Configurations

Mode <sup>1</sup>	Security	PRA, PRB	SDI, DCLK
low	don't care	user-defined I/O	user-defined I/O
high	no	Probe Circuit outputs <sup>3</sup>	Probe Circuit inputs <sup>4</sup>
high	yes <sup>2</sup>	Probe Circuit disabled	Probe Circuit disabled

In the normal operating mode (MODE=0), all undefined device pins in a design are automatically configured as active LOW outputs. You do not need to program the Security fuse to enable SDI and DCLK as active LOW outputs.

**Legend for Table 4-2**

1. The MODE pin switches the device between the normal operating mode (MODE=0) and the Probe Circuit mode (MODE=1).
2. If the Security fuse is programmed, the Probe Circuit is permanently disabled which disables the Debugger and Silicon Explorer diagnostic tools.
3. The PRA output and a separate I/O buffer share the use of a single device pin. The PRA output and the output function of the I/O buffer are multiplexed. The same is true for PRB. The Probe Mode that is loaded into the Mode Register will determine which output buffer is active during probing. There are three possible Probe Modes: “PRA only,” “PRB only,” and “PRA and PRB.”

When the “PRA only” mode is selected, the PRA output becomes active and the output function of the I/O buffer associated with the PRA pin is inhibited. However, the input buffer portion of the I/O buffer associated with the PRA pin is still active. Any internal signal that appears on the PRA output is fed back through that input buffer to the internal Logic Modules. This could interfere with the expected function of the design during probing. Actel recommends that you use an input latch on PRA and PRB to prevent the feedback while probing. PRB will function as a normal I/O in the “PRA only” mode.

The “PRB only” mode is functionally equivalent to the “PRA only” mode. PRA also functions as a normal user I/O in the “PRB only” mode.

When the “PRA and PRB” mode is selected, both the PRA and PRB outputs become active and the output function of the I/O buffers associated with both pins are inhibited. However, the input buffer of the I/O buffers associated with both pins are still active. Any internal signals that appear on the PRA and PRB outputs are fed back through the input buffers to the internal Logic Modules. This could interfere with the expected function of the design while

probing. Actel recommends that you use an input latch on PRA and PRB to prevent the feedback during probing. An input latch is an integral part of the I/O buffers in the RH1280 and A1280A devices.

4. The SDI input and a separate I/O buffer share the use of a single device pin. The SDI input and the input function of the I/O buffer are connected in parallel. When the Mode pin is high, both inputs are active. The same is true for DCLK. External Probe Circuit control signals sent to those pins are also sent to the internal Logic Modules. This could interfere with the expected function of the design while probing. Actel recommends that you use an input latch on SDI and DCLK to prevent the external Probe Circuit control signals from effecting the functionality of your design during probing. An input latch is an integral part of the I/O buffers in the RH1280 and A1280A devices.

The output function of the I/O buffers associated with SDI and DCLK do not interfere with the function of the Probe Circuitry while in the Probe Mode. When the Mode pin is driven high, these outputs are inhibited. The I/O drivers do not interfere with the external drivers. However, these outputs are not observable in the Probe Mode.



## Device Programming Failure Guidelines

This chapter contains programming failure guidelines, Activator failure guidelines, information about testing an Activator, and information about returning failed devices. Refer to Appendix A, “Troubleshooting” on page 55 for an explanation of programming failure error messages that may be displayed during programming of an Actel device.

### Programming Failure Guidelines

Programming failures are a normal and expected result of antifuse-based FPGA design. Actel performs extensive testing to measure the characteristics of the antifuses, and programs a sample of devices from every lot to ensure high programming results. However, Actel cannot guarantee that all devices will program successfully, and you should expect some programming failures.

The guaranteed quality and reliability of the devices that program successfully are unrelated to the programming yield. All devices that pass the programming function are fully guaranteed to meet all electrical, timing, and radiation specifications.

### Device Failure Rates

Commercial devices typically exhibit a 1-2% programming failure rate. If programming failures exceed the guidelines listed in the following table, contact your local sales representative or the Actel Customer Application Center at 1-800-262-1060.

Sample Size	Maximum Failures
13	3
31	5
63	8
100	10

## Activator Programming Failures

The Activators are designed to program all Actel devices. If you are experiencing a programming failure rate of greater than 2% for your devices, follow the steps below before returning the devices to Actel:

1. Check the SCSI interface and power cables to see if intermittent connections are occurring.
2. If you have access to another computer, try installing the Activator and programming software onto that computer, and programming devices to see if the yield improves.
3. If the yield problem still exists, the problem could be with the Activator. Call Actel's Customer Applications Center at 1-800-262-1060 for further assistance.

## Returning Failed Devices

If a device fails to program, you can take the following actions:

1. For normal device failure rates, return parts for replacement by requesting an RMA number through Actel's sales representatives, distributors, or customer service.
2. For device failure rates greater than those specified earlier, call the Actel Customer Applications Center at 1-800-262-1060 with information concerning any problems observed. If needed, a failure analysis can be performed.



---

## *Verifying a Device with an Activator*

This chapter describes how to use the Debugger tool in APSW and an Activator to functionally verify your programmed Actel device. This includes descriptions of available verification commands and command file usage and examples.

### *Functional Verification with an Activator*

Functional Verification of a device with the Debugger tool in APSW is done with a device placed in an Adapter Module and plugged into an Activator. Functional verification is used to test a programmed device by applying a stimulus to the input pins and observing the functional behavior at all internal nodes or nets and output pins.

Functional verification is not the same as simulating. A programmed chip is required. The output results are determined from the silicon device, not from a model stored in memory. Functional verification can be performed two ways. You can apply stimulus to the input pins by executing command-line commands or by creating command files and reading the files into APSW.

If you execute command-line commands, each command is executed before the next command can be entered. After each command is executed, output results are printed on the screen, or to a file if specified. Refer to “Debugger Command-Line Commands” on page 45 for a description of the command-line commands.

If you have a large number of commands to execute, you can create a command file. A command file contains a set of commands that are executed on your device. A command file can also contain input test vectors. If you provide expected outputs with a test vector file, Debugger compares the chip output results with the expected outputs automatically. The Debugger saves any differences it finds for further analysis. Debugger then prints the output results on the screen, or to a file if specified in the command file. Refer to “Using Command Files to Verify a Device” on page 49 for information about using command files.

## Running Debugger From APSW

Use the following procedure to initialize Debugger and verify your device.

### 1. **Invoke APSW.**

#### **Workstation**

Type the following command at the prompt:

```
apsw
```

#### **PC**

Double click the “Windows Programming” icon in the Designer Series program group.

The APSW window is displayed (see Figure 4-1 on page 28).

2. **Open the design to be verified.** Click the Open button or choose the Open command from the File menu. The Open dialog box is displayed. Type in the design name or browse to the directory that contains the “<design\_name>.adb” (or .afm) file and select it. Click OK.
3. **Verify that you have a programmed device placed in an Adapter Module plugged into the Activator.** Click the Blankcheck button or choose the Blankcheck command from the Tools menu. If a “not blank” message is displayed, the device has been programmed.
4. **Verify your device.** Click the Debugger button to initialize the tool. The message “Debugger initialization complete” is displayed when the Debugger is finished loading. Execute single command-line commands or load a command file using the loadfile command in the Command box. Refer to page 45 for information about command-line commands. Refer to “Using Command Files to Verify a Device” on page 49 for information about creating command files.

## Debugger Command-Line Commands

Command-line commands can be executed in APSW by typing the command in the Command box at the top of the APSW window and pressing Enter. Table 6-1 lists the command, syntax, and function of the command.

Table 6-1. Command-Line Commands and Functions

Command	Function
<b>Assign</b>	<p><code>assign &lt;n&gt; &lt;vector_1&gt; ... &lt;vector_n&gt;</code></p> <p>Assigns the value &lt;n&gt; to each electrical node, or vector of nodes, the next time you execute the Step command. Each node must be a chip I/O or no assignment occurs. The format of &lt;n&gt; is as follows: 0=decimal; 0b=binary; 0h=hexadecimal; 0o=octal; "01x2"=string. You can also assign a string-type constant to a vector. Valid characters are 1, 0, Z, z, X, and x. The character must be enclosed in double quotation marks. For example: assign "1Zx0" IN.</p>
<b>Comp</b>	<p><code>comp &lt;n&gt; &lt;vector_1&gt; ... &lt;vector_n&gt;</code></p> <p>Compares &lt;n&gt; to each node or vector, and prints a message for each node in the list whose value is not equal to &lt;n&gt;.</p>
<b>CompFile</b>	<p><code>compfile "&lt;PATH\filename&gt;"</code></p> <p>Opens the specified file to be used with the Fcomp command. The argument must be enclosed in double quotes.</p>
<b>Debug Socket</b>	<p><code>dbg-socket &lt;n&gt;</code></p> <p>Chooses the socket on the Activator 2 to use during verification. The value of &lt;n&gt; can be 1, 2, 3, or 4. If only 1 Adapter Module is plugged in, you do not need to use this command.</p>

Table 6-1. Command-Line Commands and Functions (Continued)

<b>Command</b>	<b>Function</b>
<b>Define Macro</b>	<p><code>define &lt;name&gt; &lt;command&gt; ... &lt;command&gt;</code></p> <p>Defines a macro. When invoked, commands specified in the macro are executed.</p>
<b>Emit</b>	<p><code>emit "&lt;example_text_string&gt;"</code></p> <p>Prints its argument to the screen and log file. The argument must be enclosed in double quotes.</p>
<b>Fassign</b>	<p><code>fassign &lt;vector_1&gt; ... &lt;vector_n&gt;</code></p> <p>Reads the value &lt;n&gt; from the input file defined by the Infile command. Assigns the value &lt;n&gt; to each electrical vector the next time you use the Step command. Each vector must be a chip I/O or no assignment occurs.</p>
<b>Fcomp</b>	<p><code>fcomp &lt;vector_1&gt; ... &lt;vector_n&gt;</code></p> <p>Compares &lt;n&gt; to each node or vector, and prints a message for each node in the list whose value is not equal to &lt;n&gt;. The value checked is read from the next line in the file opened with the Compfile command.</p>
<b>Fprint</b>	<p><code>fprint &lt;vector_1&gt; ... &lt;vector_n&gt;</code></p> <p>Prints the current values of all nodes in the Tablist to the file opened with the Outfile command.</p>
<b>ICP</b>	<p><code>icp &lt;internal_node_1&gt; &lt;internal_node_2&gt;</code></p> <p>Used for In-Circuit-Probing with an ActionProbe. It brings &lt;internal_node_1&gt; out to the probe A pin. The second argument is optional. If given, &lt;internal_node_2&gt; is brought out to the probe B pin.</p>

Table 6-1. Command-Line Commands and Functions (Continued)

Command	Function
<b>Infile</b>	<p><code>infile "&lt;PATH/infile_name&gt;"</code></p> <p>Opens an input file used with the Fassign command. The argument must be enclosed in double quotes.</p>
<b>LoadFile</b>	<p><code>loadfile "&lt;PATH/filename&gt;"</code></p> <p>Loads the specified command file and executes all the commands in the file. The PATH consists of the full path for the command file. All commands in the command file must be enclosed in parentheses.</p>
<b>OutFile</b>	<p><code>outfile "&lt;PATH/filename&gt;"</code></p> <p>Opens the specified file to be used with the Fprint command. The argument must be enclosed in double quotes.</p>
<b>Print</b>	<p><code>print &lt;vector_1&gt; ... &lt;vector_n&gt;</code></p> <p>Prints the values of the specified vector(s). If no vector is specified, the current values of all nodes in the Tablist are printed.</p>
<b>Repeat</b>	<p><code>repeat &lt;n&gt; &lt;function&gt;</code></p> <p>Repeats a sequence for &lt;n&gt; cycles. The &lt;function&gt; can be a verification command or a user-defined macro.</p>
<b>Step</b>	<p><code>step &lt;n&gt;</code></p> <p>Verifies for &lt;n&gt; cycles. If &lt;n&gt; is not specified, a default of one cycle is used.</p>

Table 6-1. Command-Line Commands and Functions (Continued)

<b>Command</b>	<b>Function</b>
<b>Stimulus High</b>	<p><code>h &lt;vector_1&gt; ... &lt;vector_n&gt;</code></p> <p>Assigns the value logical 1 to each electrical node or vector of nodes the next time you use the Step command. Each node must be a chip I/O or no assignment occurs.</p>
<b>Stimulus High-Z</b>	<p><code>z &lt;vector_1&gt; ... &lt;vector_n&gt;</code></p> <p>Sets all listed nodes to Z (high impedance) the next time you use the Step command. Each node must be a chip I/O or no assignment occurs.</p>
<b>Stimulus Low</b>	<p><code>l &lt;vector_1&gt; ... &lt;vector_n&gt;</code></p> <p>Assigns the value logical 0 to each electrical node or vector of nodes the next time you use the Step command. Each node must be a chip I/O or no assignment occurs.</p>
<b>TabAdd</b>	<p><code>tabadd &lt;vector_1&gt; ... &lt;vector_n&gt;</code></p> <p>Adds the named nodes or vectors to the list of nodes printed with the Print command. Names can be dropped by recreating the list using the Tablist command.</p>
<b>TabList</b>	<p><code>tablist &lt;vector_1&gt; ... &lt;vector_n&gt;</code></p> <p>Initializes the Tablist to the specified nodes and vectors. If no arguments are given, prints the current contents of the Tablist.</p>
<b>Vector</b>	<p><code>vector &lt;name&gt; &lt;node list&gt;</code></p> <p>Defines a vector &lt;name&gt; whose elements are the listed nodes.</p>

## Using Command Files to Verify a Device

A command file contains a series of Debugger command-line commands that when loaded into Debugger are automatically executed. Use command files to run a large number of command-line commands on your device during verification.

To create a command file use a text editor or a word processor and save the file as ASCII text. Each command in the command file must be enclosed in parentheses. Use the loadfile command to load a command file into Debugger.

Two examples are shown to illustrate how to create and use command files to verify a device. Refer to “Debugger Command-Line Commands” on page 45 for information about the available command-line commands.

### **Command File Example 1**

The following example shows a command file followed by an explanation of the file, an input file, an output file, and a comparison file:

```
(vector P P0 P1 P2 P3 P4 P5 P6 P7)
(vector Q Q0 Q1 Q2 Q3 Q4 Q5 Q6 Q7)
(tabadd PE CEP CET UD P CLK Q TC)
(infile "/designs/example/example.pat")
(outfile "/designs/example/example.out")
(compfile "/designs/example/example.cmp")
(define (clk10)(repeat 10(1 CLK)(step)(h CLK)(step)(fprint)
  (fcomp Q))
(define (up) (1 CET CEP) (h PE UD)(step)(clk10))
(define (down) (h PE) (1 CEP CET UD)(step)(clk10))
(define (load) (1PE CLK) (fassign P)(step)(h CLK)(step))
(load)
(up)
(load)
(down)
```

The first “vector” command defines eight parallel load input bits as vector P. The second vector command defines counter outputs as vector Q.

The “tabadd” command causes the signals PE, CEP, CET, UD, P, CLK, Q, and TC to be displayed or printed when the “print” or “fprint” command is executed.

The “infile” command defines and opens a file containing input test vectors (see “Example Input File” on page 50). The “outfile” command defines and opens a file for receiving Debugger output results (see “Example Output File” on page 51). The “compfile” command defines and opens a file containing the expected output values to be compared to the actual output values (see “Example Comparison File” on page 51).

The “define” commands create the following user macros:

**clk10.** The clk10 macro provides 10 clock pulses to the CLK input, prints all of the nodes specified in the tabadd command to the outfile, and compares the status of the vector Q to the expected results.

**up.** The up macro specifies the counter to count up for 10 cycles.

**down.** The down macro specifies the counter to count down for 10 cycles.

**load.** The load macro reads a load vector P from the infile and loads the counter.

The “load,” “up,” “load,” and “down” commands execute the macros, as follows: “load” loads [00000000] into the counter, “up” cycles the counter up 10, “load” loads [11111111] into the counter, and “down” cycles the counter down 10.

### ***Example Input File***

The following input file (infile) was used in this example.

```
0b00000000
0b10000000
0b01000000
0b11000000
```



### **Example Comparison File**

The following comparison file (compfile) was used in this example.

```
00010001
10010001
01010001
01111111
10111111
00111111
11011111
01011111
10011111
00011111
11101111
01101111
10101111
```

### **Example Output File**

The following output file (outfile) was created as a result of the command file used in this example.

```
1001000000001100000010
1001000000001010000010
1001000000001110000010
1001000000001001000010
1001000000001101000010
1001000000001011000010
1001000000001111000010
1001000000001000100010
1001000000001100100010
1001000000001010100010
1000111111111011111110
1000111111111011111110
1000111111111001111110
1000111111111101111110
1000111111111010111110
1000111111111100111110
1000111111111000111110
1000111111111110111110
1000111111111011011111
1000111111111010111111
```

## Command File Example 2

The following example is a command file for an 8-bit counter circuit:

```
(define (clock) (emit "Clocking\n") (h clock) (step) (l clock)
(step))
(define (clear) (l clr) (step) (h clr) (step)
  (emit "The Counter is Cleared\n"))
(vector outputs out7 out6 out5 out4 out3 out2 out1 out0)
(vector inputs in7 in6 in5 in4 in3 in2 in1 in0)
(emit "Enabling Counter B\n")
(h cen1)
(step)
(clear)
; Set input signals
(h in1 in3 in5 in7)
(l in0 in2 in4 in6)
(step)
(print inputs outputs)
(repeat 5 (clock) (print outputs))
```

The “define” commands create the “clock” and “clear” macros.

The “vector” command is used to define the “inputs” and “outputs” vectors.

The “emit” command writes text out to the screen.

The “h” and “l” commands are used to set particular signals to logic 1 (h) or logic 0 (l).

The “print” command prints the current state of “inputs” and “outputs” vectors.

The “repeat” command prints the output vector to the screen after every clock cycle.

***Example Output File***

The following output file (outfile) was created as a result of the command file used in this example.

```
Enabling Counter
The Counter is Cleared
inputs   = 10101010
outputs  = 00000000
Clocking
outputs  = 00000001
Clocking
outputs  = 00000010
Clocking
outputs  = 00000011
Clocking
outputs  = 00000010
Clocking
outputs  = 00000011
```



---

## Troubleshooting

This appendix describes some common problems you may encounter with the Activator, Adaptec 1505A SCSI card, or APSW or APS2 software and their solutions. If you are still unable to resolve your problems after reading this Appendix contact Actel's Customer Applications Center.

### *Driver Does Not Load under Windows*

*Problem:* The software driver does not load during boot-up.

*Solution:* Check for the following:

- The 1505A card is installed properly.
- The IRQ and I/O address settings match between the 1505A card and the software driver.
- The software driver is the correct one.
- There are no hardware conflicts.

Refer to Chapter 2, "Hardware Installation on a PC" on page 7 for information.

### *Activator*

This section describes problems you may encounter with an Activator and their solutions.

#### ***Green Power Light is Blinking***

*Problem:* The green power light is blinking after the power is turned on.

*Solution:* A self test has failed. Contact Actel for a replacement Activator.

### **Activator Communication Link Down**

*Problem:* The following error message appears:

```
ERROR: Activator communication link down. Exiting...
```

*Solution:* There is a problem with the connection between the Activator and the PC, or the Activator has lost power. Check the connections (the Activator power light should be illuminated), and try re-invoking APSW.

### **Firmware Load Failed**

*Problem:* No contact with the programmer is found and the following error message appears:

```
Firmware load failed. WARNING: Could not connect with Activator.
```

*Solution:* Check that you have turned on the Activator, that the SCSI cable is correctly installed, and the SCSI cable connection to the workstation is secure. The locking arms on the SCSI board can be misaligned. Also, verify that the device driver(s) are installed correctly. Refer to Chapter 2, "Hardware Installation on a PC" on page 7 or Chapter 3, "Hardware Installation on a Workstation" on page 19 for information about configuring drivers.

### **Wrong Adapter Module**

*Problem:* The incorrect Adapter Module is inserted in the Activator and the following error message appears:

```
FAILED-Wrong adapter module
```

*Solution:* Remove the Adapter Module and replace it with the correct one. The design may have also been configured with a different package or device type.

## Old Revision

If the Adapter Module does not support the selected device, even if the correct package is selected, the following message is displayed:

```
Old revision adapter module
```

## AFM File

This section describes problems that you may encounter when opening an AFM file and their solutions.

### AFM File Generation

*Problem:* Generating the AFM file is taking a long time.

*Solution:* Depending on device type, device utilization, and machine speed, this process could take a few minutes. If 15 minutes have passed without completion, the hard disk may be out of memory. Exit APSW and check available disk space. If there is less than 1 megabyte, free up some disk space and try generating the .afm file again.

### AFM Generation Failure

*Problem:* AFM file generation failed.

*Solution:* The software could not find a valid FUS file. The file may not be present or it may have been created with a release prior to ALS 1.22. You must regenerate the FUS file using Designer.

## Fuse

This section describes problems that you may encounter during programming and their solutions.

### Failed Fuse

*Problem:* The following error message appears:

```
FAILED—fuse XXX integrity test 6, 7, or 8
```

*Solution:* This message often indicates that the device is bad. If you observe a programming failure rate in excess of 5%, contact the Actel Customer Application Center at 1-800-262-1060.

## Failed Programming Fuse

*Problem:* The following error message appears:

```
FAILED-programming fuse XXXX
```

*Solution:* This message often indicates that the device is bad. If you observe a programming failure rate in excess of 5%, contact the Actel Customer Application Center at 1-800-262-1060.

When an antifuse is programmed, multiple voltage pulses are applied to the  $V_{PP}$  pin. While the pulses are applied,  $I_{PP}$  current is checked. If the antifuse is open (unprogrammed), there will be no  $I_{PP}$  current. The Activator can tell if the antifuse has been programmed once it detects  $I_{PP}$  current. Pulses are applied until  $I_{PP}$  current is detected, or the maximum number of pulses is exceeded. If the antifuse does not program after the maximum number of pulses are applied, a “FAILED Programming Fuse” message is displayed on the screen and the failed antifuse number is shown.

BAD fuse failures are often caused by a poor connection of the  $V_{PP}$  pin to the socket pin. This is especially true if the part fails programming on the first antifuse. Remove the part and check for bent pins. If the pins are not bent and the other parts continue to fail with the “FAILED Programming Fuse” error, then the  $V_{PP}$  pin of the socket could be damaged. Contact Actel’s Customer Applications Group.

## SCSI Controller

*Problem:* SCSI Controller not found.

*Solution:* The SCSI controller board has not been installed in the PC, or there is an I/O address conflict. Also, verify that the device driver(s) are installed correctly. Refer to the Hardware Installation chapter specific to your computer for information about configuring drivers. If you are working on a workstation, verify that no other APSW processes are running. Only one APSW process may run at a time.



## Fuse Failures

This section describes failure messages that appear when a fuse fails to program.

### Check 6 Failure

Once the antifuse has been programmed, the Activator addresses the same antifuse again and checks for  $I_{PP}$  current at a lower  $V_{PP}$  voltage. This is to make sure that the antifuse was correctly addressed the first time and that the  $I_{PP}$  current did not come from another source. If no current is detected with this new test, the chip fails programming and APSW/APS2 issues the “Integrity test 6” failure for the antifuse. Once again, the antifuse number that failed is displayed.

### Check 7 and 8 Failures

This test is only performed on ACT 1 and 40MX devices. After the Activator completes the “CHECK 6” test, it then does two additional tests to make sure that an additional antifuse was not programmed mistakenly. The first test checks antifuses on the same column as the programmed antifuse, and the second test checks the same row. The tests are done by addressing these other antifuses, applying a voltage to  $V_{PP}$  and making sure no  $I_{PP}$  current is detected. If the tests fail ( $I_{PP}$  current is detected), a “FUSE INTEGRITY FAILURE” failure is displayed.

## Error Messages

This section describes general programming error messages that might be displayed.

### Integrity Test

Incorrectly programmed fuses, like the Check 7 and 8 failures above, are reported in the following format:

```
Integrity test <test type>. <test number>
```

This message indicates that the device is a programming reject. Actel will replace devices that fail programming.

### **Fuse Current Sense Test**

This test is not performed on ACT 1 or 40MX devices. This test is done to ensure that a logic module output is not inadvertently programmed to GND or VCC. The error message's format is the following:

```
Fuse <fuse number>, current sense test <test number>
```

### **Not Blank**

If the device has been programmed and programming is attempted, the following message is displayed:

```
Not blank
```

## **Silicon Explorer**

This section describes error messages that might be displayed during debugging using the Silicon Explorer diagnostic tool, and the reason the message is displayed.

### **POLL Message**

*Problem:* I've connected Probe Pilot and the Analyze window display reads "POLL."

*Solution:* Look on the top of the Probe Pilot for the flashing yellow LED. If it isn't flashing, make sure you have properly connected an adequate power supply.

*Problem:* It's flashing but still POLL.

*Solution:* There are a number of things that can prevent communication from being established. The following lists the most common:

1. Wrong COM port. Try all four COM ports even though you're sure that your mouse is on COM 1.
2. No power to the analyzer.
3. Desktop Systems External connector not connected to the COM port internally.
4. Laptop Systems external COM connector disabled. Use your PC's CMOS setup program to enable the COM port.

5. Com port IRQ reassigned for DOS program, control panel not updated.
6. Multiple mouse drivers in system.ini.
7. Third-party serial port “enhancers” not conforming to windows API.

### **IDLE**

*Problem:* I’ve got the IDLE message but when I click on Run, the Analyze window flashes an error message and returns to IDLE.

*Solution:* If the target power is incapable of supplying the necessary current, then the Analyze window resets and returns to IDLE. Many current-limiting supplies will trip when set too close to the operating current.

### **Read-Back Error**

*Problem:* The Analyze window acquires data and then indicates errors on read-back.

*Solution:* The Analyze window bursts data back in blocks at high speeds, with built-in retry for a bad block (both Checksum and byte count are used). Some third-party serial programs block all interrupts forcing the analyzer into a retry loop. Some laptops power down the UART and drop a few characters. Try disabling “Power Saving” in the CMOS setup menu.

### **Windows Runs Slow**

*Problem:* When the Analyze window is open, my other Windows programs run slow.

*Solution:* If the Analyze window is open but it is not connected or powered up, then the system is constantly timing out looking for a response. Either close the Analyze window or change the COM port to DEMO.



## AVI File Description

The AVI file is a log file generated while an Actel FPGA is programmed. The file contains information about the number of  $V_{PP}$  pulses applied to each fuse to program the fuse and the programming current sensed through each fuse. If a programming failure occurs, the AVI file contains information about the programming failure mode.

A new AVI file is generated each time the programming sequence begins. If you want to save an AVI file, you must re-name it before restarting the programming sequence. The following excerpt shows an example AVI file:

```
*****
; FILEID AVI \example.avi
; PROGRAM Activator (tm) 2 Programming System 3.1.1
; VAR DDFDIE c:\ACTEL\data/a1200/1280/G1280.ddf
; VAR DDFPACKAGE c:\ACTEL\data/a1200/1280/qfp172.ddf
; VAR FUS \designs\mod25\mod25.fus
; VAR AFM \designs\mod25\mod25.afm: Compressed
; VAR SIG
; ACT-FUSE: Fuse 1
; SILICON-SIGN 4: 5F80000 FFE 600000 0 FD335C
; ICC-STANDBY: 22 - - -
; IPP-STANDBY:0
; ESBIN: 3
; START-TIME Mon Mar 18 17:59:12 1996
; 4 3 2 1
1: 146 11 - - - - -
2: 146 7 - - - - -
3: 146 10 - - - - -
4: 146 8 - - - - -
5: 146 8 - - - - -
6: 146 9 - - - - -
7: 146 11 - - - - -
8: 146 7 - - - - -
9: 146 4 - - - - -
10: 146 8 - - - - -
11: 146 10 - - - - -
12: 146 20 - - - - -
13: 146 10 - - - - -
14: 146 5 - - - - -
15: 146 15 - - - - -
16: 146 18 - - - - -
17: 146 9 - - - - -
18: 146 11 - - - - -
*****
```

The first thirteen lines of the file shown above contain header information. This information is obtained from both the programming file (.afm or .fus) and the unit being programmed. Each line of the AVI file header is preceded by a semi-colon. The header contains the following information:

- The complete Silicon Signature (read from the device) prior to programming.
- The  $I_{CC}$  standby value of the device before it is programmed. In the example, the  $I_{CC}$  standby of 22 corresponds to a standby of 2.2mA.
- The device “esbin” number, which corresponds to the  $V_{PP}$  used during programming.

The remainder of the AVI file contains information about the programming sequence. As each fuse is programmed, a new line is added to the AVI file. The first column of numbers in the AVI file is the fuse number. A typical RH1280 design requires approximately 15700 fuses to be programmed. The AVI file would contain over 15700 lines, including header information.

There are 8 additional columns in the AVI file. The 8 columns are listed in groups of 2, with each group corresponding to a socket on the Activator 2 (sockets are numbered 1-4). If the Activator 2s is used, the single socket is always recognized as socket 4.

The first column in a group of 2 contains the final programming current sensed by the Activator through each fuse as it is programmed. The programming current is listed in tenths of milliamps, and no decimal point appears in the number. For example, a programming current listed as 146 corresponds to current of 14.6mA . It is not unusual for different fuse types to have different programming currents.

The second column in a group of 2 contains the number of  $V_{PP}$  pulses that were required to program a specific fuse. The maximum number of programming pulses reported in the AVI file is 64464 pulses. There is an inherent variation in the number of pulses required to program a fuse depending on the fuse type. A wide distribution of  $V_{PP}$  pulse counts can be expected.

After the array fuse programming information, test results from the “end of programming” tests executed by the Activator are stored. If any of these tests fail, the failing test is indicated in the AVI file.

---

## *Product Support*

Actel backs its products with various support services including Customer Service, a Customer Applications Center, a Web and FTP site, electronic mail, and worldwide sales offices. This appendix contains information about using these services and contacting Actel for service and support.

### *Actel U.S. Toll-Free Line*

Use the Actel toll-free line to contact Actel for sales information, technical support, requests for literature about Actel and Actel products, Customer Service, investor information, and using the Action Facts service.

The Actel Toll-Free Line is (888) 99-ACTEL.

### *Customer Service*

Contact Customer Service for non-technical product support, such as product pricing, product upgrades, update information, order status, and authorization.

From Northeast and North Central U.S.A., call (408) 522-4480.

From Southeast and Southwest U.S.A., call (408) 522-4480.

From South Central U.S.A., call (408) 522-4434.

From Northwest U.S.A., call (408) 522-4434.

From Canada, call (408) 522-4480.

From Europe, call (408) 522-4252 or +44 (0) 1256 305600.

From Japan, call (408) 522-4743.

From the rest of the world, call (408) 522-4743.

Fax, from anywhere in the world (408) 522-8044.

## Customer Applications Center

The Customer Applications Center is staffed by applications engineers who can answer your hardware, software, and design questions.

All calls are answered by our Technical Message Center. The center retrieves information, such as your name, company name, phone number and your question, and then issues a case number. The Center then forwards the information to a queue where the first available application engineer receives the data and returns your call. The phone hours are from 7:30 a.m. to 5 p.m., Pacific Standard Time, Monday through Friday.

The Customer Applications Center number is (800) 262-1060.

European customers can call +44 (0) 1256 305600.

## Guru Automated Technical Support

Guru is a Web based automated technical support system accessible through the Actel home page (<http://www.actel.com/guru/>). Guru provides answers to technical questions about Actel products. Many answers include diagrams, illustrations and links to other resources on the Actel Web site. Guru is available 24 hours a day, seven days a week.

## Web Site

Actel has a World Wide Web home page where you can browse a variety of technical and non-technical information. Use a Net browser (Netscape recommended) to access Actel's home page.

The URL is <http://www.actel.com>. You are welcome to share the resources we have provided on the net.

Be sure to visit the "Actel User Area" on our Web site, which contains information regarding: products, technical services, current manuals, and release notes.



## *FTP Site*

Actel has an anonymous FTP site located at **ftp://ftp.actel.com**. You can directly obtain library updates, software patches, design files, and data sheets.

## *Electronic Mail*

You can communicate your technical questions to our e-mail address and receive answers back by e-mail, fax, or phone. Also, if you have design problems, you can e-mail your design files to receive assistance. The e-mail account is monitored several times per day.

The technical support e-mail address is **tech@actel.com**.

## Worldwide Sales Offices

### Headquarters

Actel Corporation  
955 East Arques Avenue  
Sunnyvale, California 94086  
Toll Free: 888.99.ACTEL

Tel: 408.739.1010  
Fax: 408.739.1540

### US Sales Offices

#### California

Bay Area  
Tel: 408.328.2200  
Fax: 408.328.2358

Irvine  
Tel: 949.727.0470  
Fax: 949.727.0476

San Diego  
Tel: 619.938.9860  
Fax: 619.938.9887

Thousand Oaks  
Tel: 805.375.5769  
Fax: 805.375.5749

#### Colorado

Tel: 303.420.4335  
Fax: 303.420.4336

#### Florida

Tel: 407.677.6661  
Fax: 407.677.1030

#### Georgia

Tel: 770.831.9090  
Fax: 770.831.0055

#### Illinois

Tel: 847.259.1501  
Fax: 847.259.1572

#### Maryland

Tel: 410.381.3289  
Fax: 410.290.3291

#### Massachusetts

Tel: 978.244.3800  
Fax: 978.244.3820

#### Minnesota

Tel: 612.854.8162  
Fax: 612.854.8120

#### North Carolina

Tel: 919.376.5419  
Fax: 919.376.5421

#### Pennsylvania

Tel: 215.830.1458  
Fax: 215.706.0680

#### Texas

Tel: 972.235.8944  
Fax: 972.235.965

### International Sales Offices

#### Canada

Suite 203  
135 Michael Cowpland Dr,  
Kanata, Ontario K2M 2E9

Tel: 613.591.2074  
Fax: 613.591.0348

#### France

361 Avenue General de Gaulle  
92147 Clamart Cedex

Tel: +33 (0)1.40.83.11.00  
Fax: +33 (0)1.40.94.11.04

#### Germany

Bahnhofstrasse 15  
85375 Neufahrn

Tel: +49 (0)8165.9584.0  
Fax: +49 (0)8165.9584.1

#### Hong Kong

Suite 2206,  
Parkside Pacific Place,  
88 Queensway

Tel: +011.852.2877.6226  
Fax: +011.852.2918.9693

#### Italy

Via Giovanni da Udine No. 34  
20156 Milano

Tel: +39 (0)2.3809.3259  
Fax: +39 (0)2.3809.3260

#### Japan

EXOS Ebisu Building 4F  
1-24-14 Ebisu Shibuya-ku  
Tokyo 150

Tel: +81 (0)3.3445.7671  
Fax: +81 (0)3.3445.7668

#### Korea

135-090, 18th Floor,  
Kyoung Am Building  
157-27 Samsung-dong  
Kangnam-ku, Seoul

Tel: +82 (0)2.555.7425  
Fax: +82 (0)2.555.5779

#### Taiwan

4F-3, No. 75, Sec. 1,  
Hsin-Tai-Wu Road,  
Hsi-chih, Taipei, 221

Tel: +886 (0)2.698.2525  
Fax: +886 (0)2.698.2548

#### United Kingdom

Daneshill House,  
Lutyens Close  
Basingstoke,  
Hampshire RG24 8AG

Tel: +44 (0)1256.305600  
Fax: +44 (0)1256.355420

---

# Index

1505A Card. *See* Adaptec AVA-1505A AT-to-SCSI Adapter

## A

Actel

FTP Site 67

Manuals x

Web Based Technical Support 66

Web Site 66

ActionProbe

Command 30

Port 2

Activate Command 29

Activator

ActionProbe Port 2

Activator 2 Rear Panel 2

Activator 2 Test Port Connector 4

Activator 2s DIN Power Jack 4

Activator 2s Power Supply 16, 20, 22, 25

Activator 2s Rear Panel 3

Adapter Module 3

Common Connectors 2

Connecting to an Adaptec SCSI Card 14

Power Switch 3

SCSI Port 3

SCSI Rotary Switch 3

Troubleshooting 55

Unpacking 1

Verification 43–53

Adaptec AVA-1505A AT-to-SCSI Adapter

Background Information 7

Connecting an Activator 14

I/O Address Default Setting 4

Installation 7–14

Installation Steps 8

Installing into an AT Expansion Slot 9, 12

Installing Under Windows 95 8

Installing Under Windows NT 11

Adaptec SCSI Card 14

Adapter Module 3, 4

Installing 17, 26

Removing 17, 26

Troubleshooting 56

ADB File 31

Add New Hardware Wizard, Windows 95 9

AFM File 31

Troubleshooting 57

Append, Command Line 15

APSW

ActionProbe 30

Activate Command 29

Blankcheck Command 29

Checksum Command 29

Command Box 31

Debugger Command 30

Description 28

Invoking From a PC 33

Invoking From a Workstation 33

Opening a Design 33

Programming a Device 31

Programming Files 31

Assign Command 45

Assumptions x

AT Bus 7

Expansion Slot 9, 12

AVI File 34, 63

Description 63–64

## B

Blankcheck Command 29

Bus

AT 7

ISA 7  
PCI 7

## C

Checksum Command 29  
Command Box 31  
Command File 49  
    Comparison File 51  
    Entering Commands 49  
    Input File 50  
    Loading 49  
    Output File 51, 53  
Command Line  
    Append 15  
    Commands 45  
Common Connectors 2  
    ActionProbe Port 2  
    Adapter Module 3  
    Power Switch 3  
    SCSI Port 3  
    SCSI Rotary Switch 3  
Comp Command 45  
CompFile Command 45  
Configuring  
    Software Driver, Windows 95 10  
    Software Driver, Windows NT 12, 13  
    Termination Resistors 11, 14  
Conflict  
    I/O Address 7, 11, 13  
    IRQ 7, 11, 13  
Connecting an Adaptec SCSI Card 14  
Contacting Actel  
    Customer Service 65  
    Electronic Mail 67  
    Technical Support 66  
    Toll-Free 65

    Web Based Technical Support 66  
Conventions x  
Creating a Link to an Activator  
    HP-UX 25  
    Solaris 23  
    SunOS 21  
Customer Service 65

## D

Debugger Command 30, 45–47  
    Assign 45  
    Comp 45  
    CompFile 45  
    Define 46  
    Emit 46  
    Fassign 46  
    Fcomp 46  
    Fprint 46  
    High 48  
    High-Z 48  
    ICP 46  
    InFile 47  
    LoadFile 47  
    Low 48  
    OutFile 47  
    Repeat 47  
    Socket 45  
    Step 47  
    TabAdd 48  
    TabList 48  
    Vector 48  
DEF File 31  
Default I/O Address 4  
Define Command 46  
Device  
    Handling Guidelines 1

Handling Procedure 32  
 Programming 31  
 DIN Power Jack 4  
 Document Assumptions x  
 Document Conventions x  
 Document Organization ix

**E**

Electronic Mail 67  
 Emit Command 46  
 Entering Commands in a Command File 49  
 Error Messages 59  
 ESD Handling Guidelines 1  
 Existing Adaptec SCSI Card, Setting SCSI ID 14

**F**

Failed Device 41  
 Fassign Command 46  
 Fcomp Command 46  
 Fprint Command 46  
 FUS File 31  
 Fuse Failures 59  
   Troubleshooting 57

**H**

Hardware  
   Activator Rear Panel 2  
   Adapter Module 4  
   Adding under Windows 95 9  
   Conflict 7  
 High Command 48  
 High-Z Command 48

**I**

I/O Address 7, 10  
   Conflict 11, 13

  Selecting, Windows 95 8  
   Selecting, Windows NT 4.0 12  
 ICP Command 46  
 InFile Command 47  
 Installation  
   Activator on a PC 15  
   Activator on a Solaris Workstation 21  
   Activator on a SunOS Workstation 19  
   Activator on an HP-UX Workstation 24  
   Adaptec AVA-1505 AT-to-SCSI Adapter 7–14  
   Adapter Module 17, 26  
   ASPI Driver, Windows NT 13  
   Background Information, Adaptec SCSI Card 7  
   Windows NT Driver 12  
 IRQ 7, 10  
   Conflict 11, 13  
   Selecting, Windows 95 8  
   Selecting, Windows NT 4.0 12  
 ISA Bus 7

**L**

Legacy Card 7  
 Linking an Activator to a Workstation  
   HP-UX 25  
   Solaris 23  
   SunOS 21  
 LoadFile Command 47  
 Loading a Command File 49  
 Low Command 48

**O**

On-Line Help xiii  
 OutFile Command 47

**P**

PCI Bus 7

- Plug and Play Card 7
- Power Switch 3
- Product Support 65–68
  - Customer Applications Center 66
  - Customer Service 65
  - Electronic Mail 67
  - FTP Site 67
  - Technical Support 66
  - Toll-Free Line 65
  - Web Site 66
- Program Fuse 34
- Program Fuse Configurations 34
- Programming
  - APSW 31
  - Checklist 32
  - Error Messages 59
  - Failure Guidelines 41
  - Failure Rates, RadTolerant 41
  - File Types, APSW 31
  - Fuse Configurations 34
  - Fuse Failures 59
  - Program Fuse 34
  - Security Fuse 34

## R

- Rear Panel 2–4
  - ActionProbe Port 2
  - Adapter Module 3
  - Common Connectors 2
  - DIN Power Jack 4
  - Power Switch 3
  - SCSI Port 3
  - SCSI Rotary Switch 3
  - Test Port 4
- Related Manuals x
- Repeat Command 47

## S

- SCSI
  - Port 3
  - Rotary Switch 3, 15
  - Troubleshooting 58
- SCSI ID, Existing SCSI Card 14
- Security Fuse 34
  - ACT 1/40MX 35
  - Configurations 34
  - Non-ACT 1/40MX 37
  - PROBE 35
  - PROGRAM 35
- Selecting IRQ and I/O Address
  - Windows 95 8
  - Windows NT 12
- Silicon Explorer
  - Troubleshooting 60
- Silicon Signature 31
- Socket Command 45
- Software Driver, Verifying
  - Windows 95 11
  - Windows NT 14
- Step Command 47

## T

- TabAdd Command 48
- TabList Command 48
- Technical Support 66
- Termination Resistors 11, 14
- Test Port 4
- Toll-Free Line 65
- Troubleshooting 55–61
  - Activator 55
  - Adapter Module 56
  - AFM File 57
  - Fuse Failures 57, 59

Programming Error Messages 59

SCSI Controller 58

Silicon Explorer 60

Software Driver 55

## U

Unpacking an Activator 1

Using an Existing Adaptec SCSI Card 14

    Setting SCSI ID 14

## V

Vector Command 48

Verification 43–53

Verifying

    Software Driver Install, Windows NT 14

Verifying Software Driver Install

    Windows 95 11

    Windows NT 13

## W

Web Based Technical Support 66

Windows Software Driver

    95 10

    NT 12, 13